

BuzziFalls
Soundabsorbing Hanging Panel

asset
space becomes place

BuzziFalls

Product Specification Sheet

Discover all insights on BuzziFalls.
Acoustical room dividers offering you a
variety of patterns, sizes and colors to
organize your space.









www.buzzi.space

A playful solution to regulate sounds

To divide a space and create some privacy, the BuzziFalls are a new playful variation in our acoustic solutions gamma. These strips are made out of BuzziFelt with cut-out shapes in various patterns, for example falling leaves. A playful solution to regulate sounds and create smaller areas in big spaces.

Design by Sas Adriaenssens

General

-  Pattern: Alhambra, Birch, Cubes, Dots, Grid, Honey, Leaves, Orient, Palms, Parrots, Pebbles, Plain, Rain, Squares, Stars, Royal, Tropics, Waves
-  2 layers of BuzziFelt
-  Profile metal powdercoated black | RAL 9005 matte or metal powdercoated White | RAL 9010 matte
Pendant black steel cable for black profile | alu steel cable for white profile
-  Pattern: W 80 cm H 220 or 250 cm D 1 cm
W 31.50" H 86.61 or 98.42" D 0.40"
-  BuzziFall Wall | Ceiling mounted, Ceiling suspended or Ceiling and floor suspended
Cable L 2 or 5 m, Ø 1,5 mm
L 78.74 or 196.85", Ø 0.06"
-  Possibility to connect several BuzziFalls
Rail (1 | 2 | 3 falls in 1 rail)
Extra rail for extension
Bicolor

Acoustics



Absorption



Diffusion



Attenuation



High tone

Certifications



Content

Fabrics	3	Option Rail	10
Patterns	4	Dimensions	11
Fixing systems	6	Acoustics	13

Fabrics

Felt*

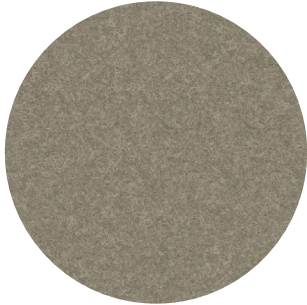

Composition 100% Recycled PE.T. Felt, latex backing
Weight 1.000 g/m2 | 29.49 oz/yd2
Abrasion resistance >7.000 Martindale
Flammability EU: EN 13501.1 + A1/2009 Class B-s1,d0
USA: ASTM E84 Class A certified
Fastness to light USA 5



* not available in EcoBrown 58

Felt Printed**



Concrete

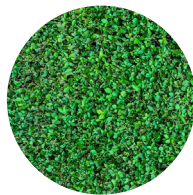

Green 1



Green 2



Jungle

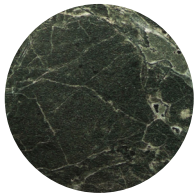

Marble Absynth

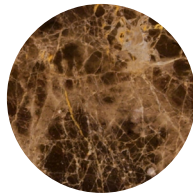

Marble Emperador



Camo Amazon



Camo Taiga



Camo Desert



Camo Snow

**Technical Specification same as Felt

Patterns

* Pattern will be slightly modified for ceiling and floor suspended option

Alhambra

250 cm 98.42"
3,1 kg 6.83 lbs

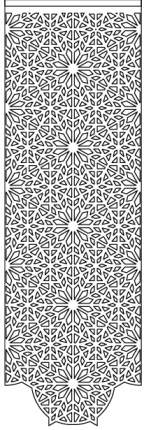

Birch

220 cm 86.61"
2,8 kg 6.17 lbs

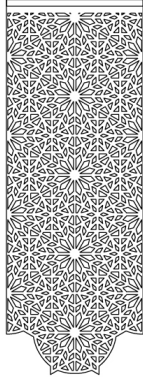

Birch

250 cm 98.42"
2,6 kg 5.70 lbs

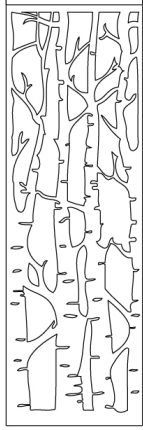

Cubes

220 cm 86.61"
2,5 kg 5.51 lbs



Cubes

250 cm 98.42"
3,9 kg 8.71 lbs

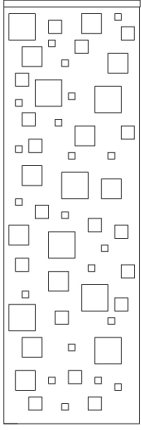

Dots

220 cm 86.61"
3,4 kg 7.56 lbs

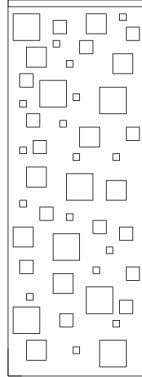

Dots

250 cm 98.42"
4,6 kg 10.14 lbs

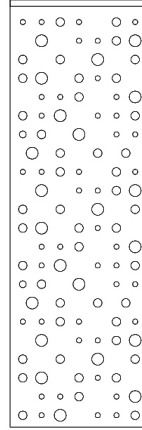

220 cm 86.61"
4 kg 8.82 lbs

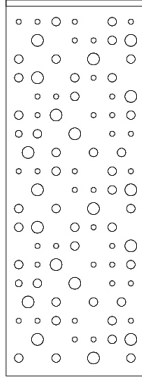

Grid

250 cm 98.42"
3 kg 6.61 lbs

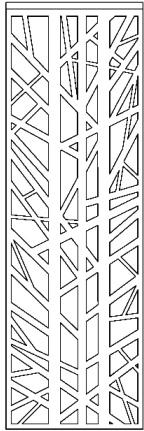

Honey

220 cm 86.61"
2,6 kg 5.73 lbs

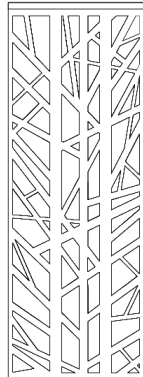

Honey

250 cm 98.42"
3 kg 6.61 lbs

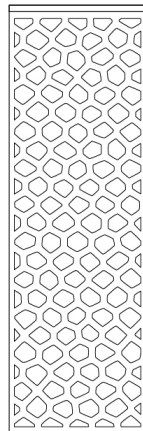

Leaves

220 cm 86.61"
2,6 kg 5.73 lbs

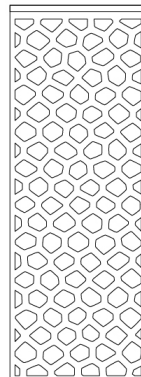

Leaves

250 cm 98.42"
3,1 kg 6.83 lbs



Orient

220 cm 86.61"
2,8 kg 6.17 lbs



Orient

250 cm 98.42"
3,7 kg 8.16 lbs



220 cm 86.61"
3,3 kg 7.27 lbs



Palms

250 cm 98.42" **220 cm 86.61"**
4,3 kg 9.48 lbs **3,8 kg 8.38lbs**

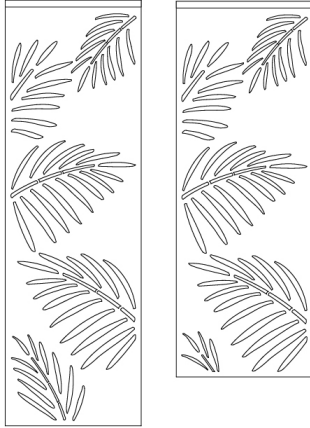

Parrots

250 cm 98.42" **220 cm 86.61"**
3,6 kg 7.94 lbs **3,2 kg 7.05 lbs**



Pebbles

250 cm 98.42" **220 cm 86.61"**
2 kg 4.41 lbs **1.8 kg 3.97 lbs**

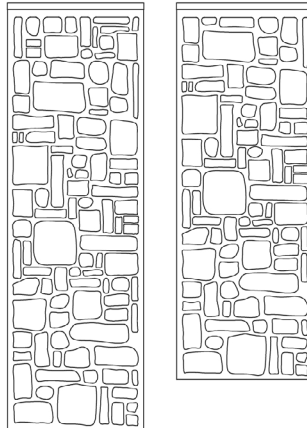

Plain

250 cm 98.42" **220 cm 86.61"**
5,2 kg 11.46 lbs **4,5 kg 9.92 lbs**

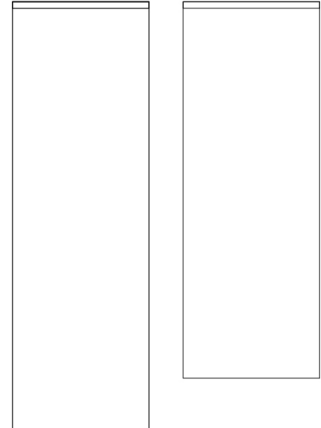

Rain

250 cm 98.42" **220 cm 86.61"**
3,9 kg 8.60 lbs **3,4 kg 7.50 lbs**

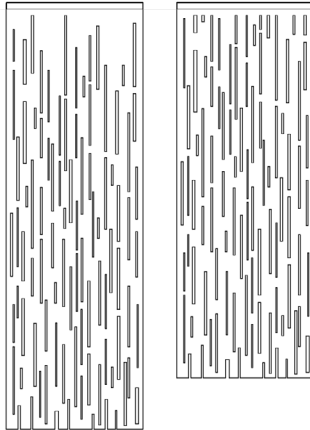

Royal

250 cm 98.42" **220 cm 86.61"**
3,6 kg 8.00 lbs **3,2 kg 7.05 lbs**

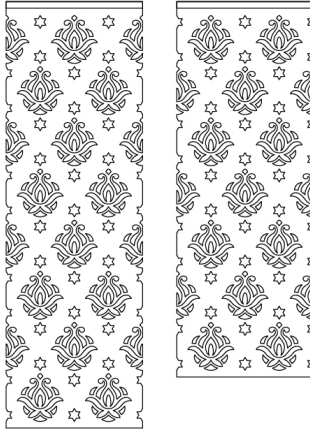

Squares

250 cm 98.42" **220 cm 86.61"**
4,3 kg 9.41 lbs **3,8 kg 8.33 lbs**

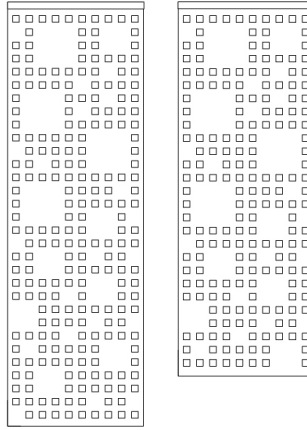

Stars

250 cm 98.42" **220 cm 86.61"**
4,9 kg 10.87 lbs **4,3 kg 9.57 lbs**

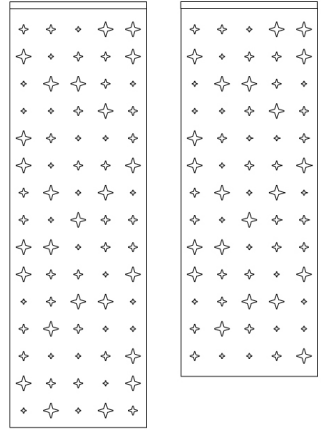

Tropics

250 cm 98.42" **220 cm 86.61"**
3,1 kg 6.83 lbs **2,7 kg 5.95 lbs**

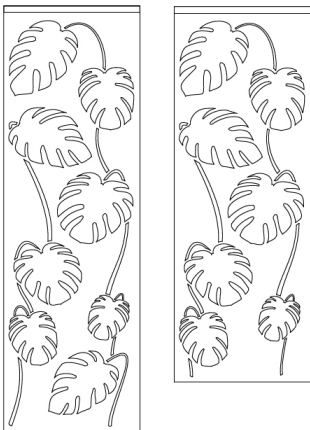

Waves

250 cm 98.42" **220 cm 86.61"**
2,8 kg 6.17 lbs **2,5 kg 5.51 lbs**

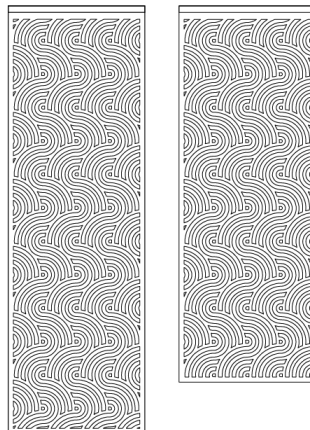

Fixing Systems

BuzziFalls Ceiling Suspended

BuzziFalls Ceiling Suspended > 1

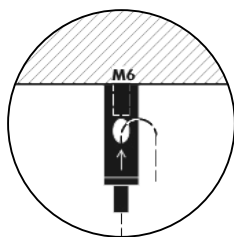
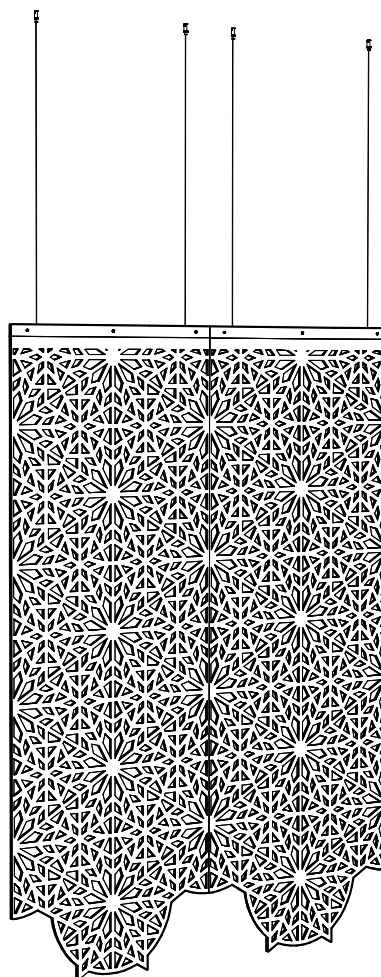
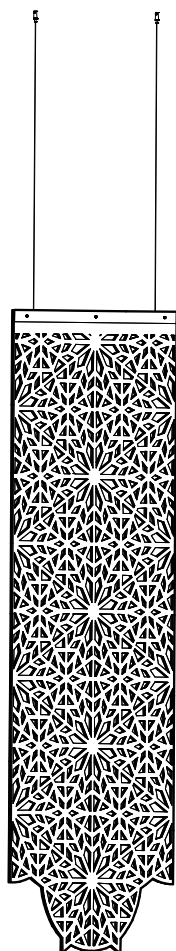

Profile black or white

2 cables per set, incl. fastner
(stair bolts M6)

Black or alu colored cable
L 200 or 500 cm, Ø 1,5 mm
L 78.74" or 196.85", Ø 0.06"

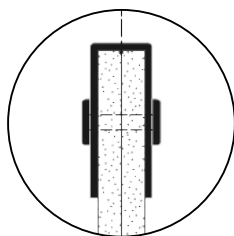

BuzziFalls Ceiling and Floor Suspended

BuzziFalls Ceiling and Floor Suspended > 1

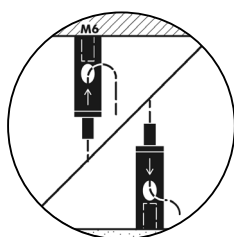
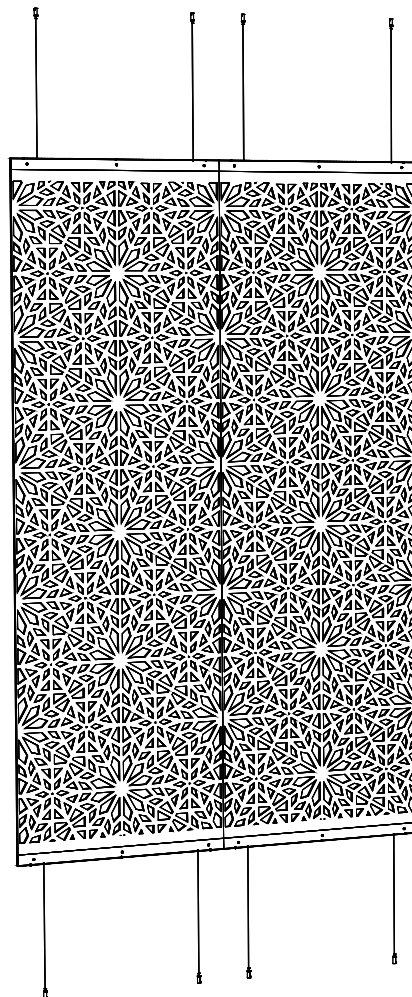
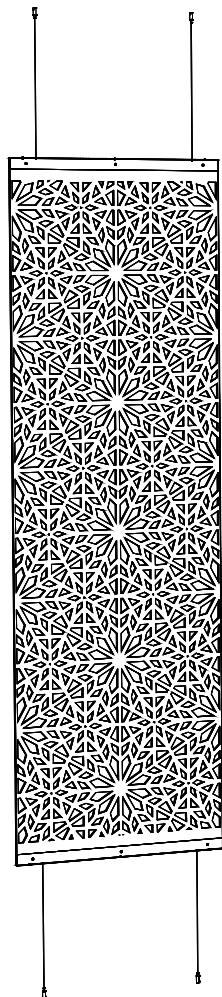

Profile black or white (same color for 2 profiles)

Ceiling

2 cables, incl. fastner

(stair bolts M6)

Black or alu colored cable

L 200 or 500 cm, Ø 1,5 mm

L 78.74" or 196.85", Ø 0.06"

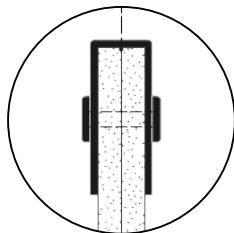

Floor

2 cables, incl. fastner

(stair bolts M6)

Black or alu colored cable

L 200, Ø 1,5 mm

L 78.74", Ø 0.06"

BuzziFalls Ceiling Mounted

BuzziFalls Ceiling Mounted > 1

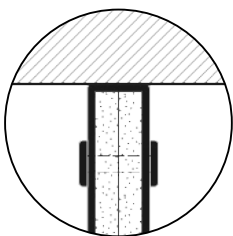
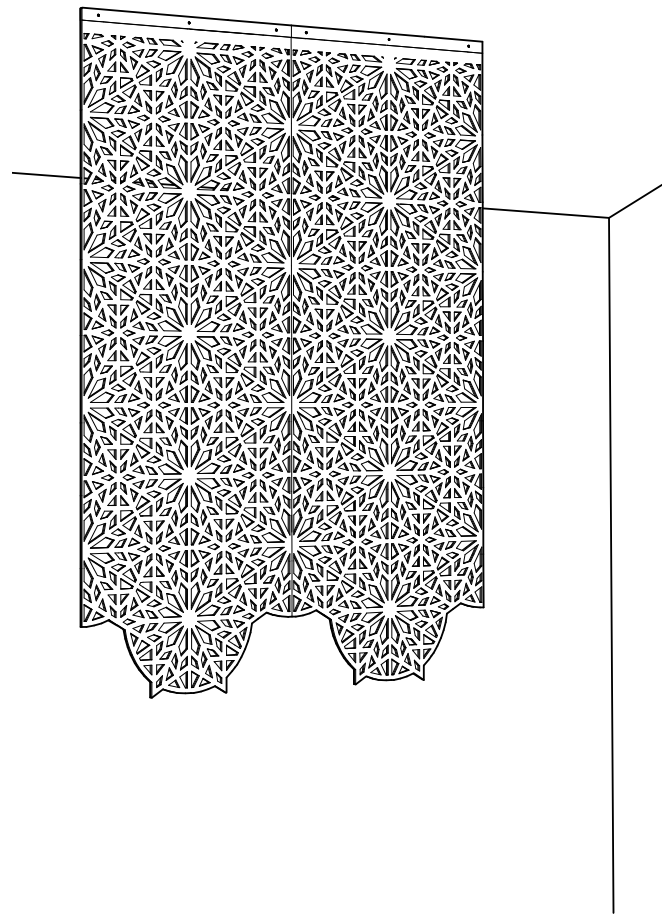
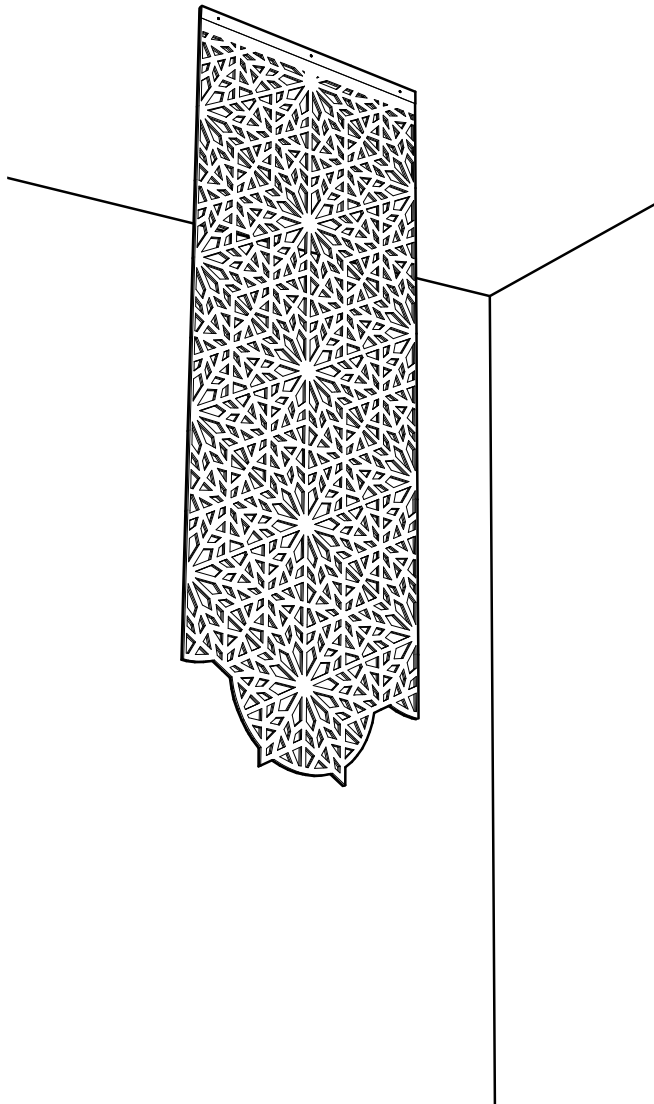

Profile black or white

BuzziFalls Wall Mounted

BuzziFalls Wall Mounted >1

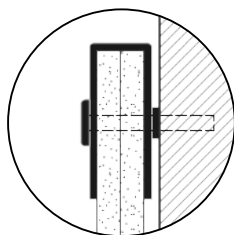
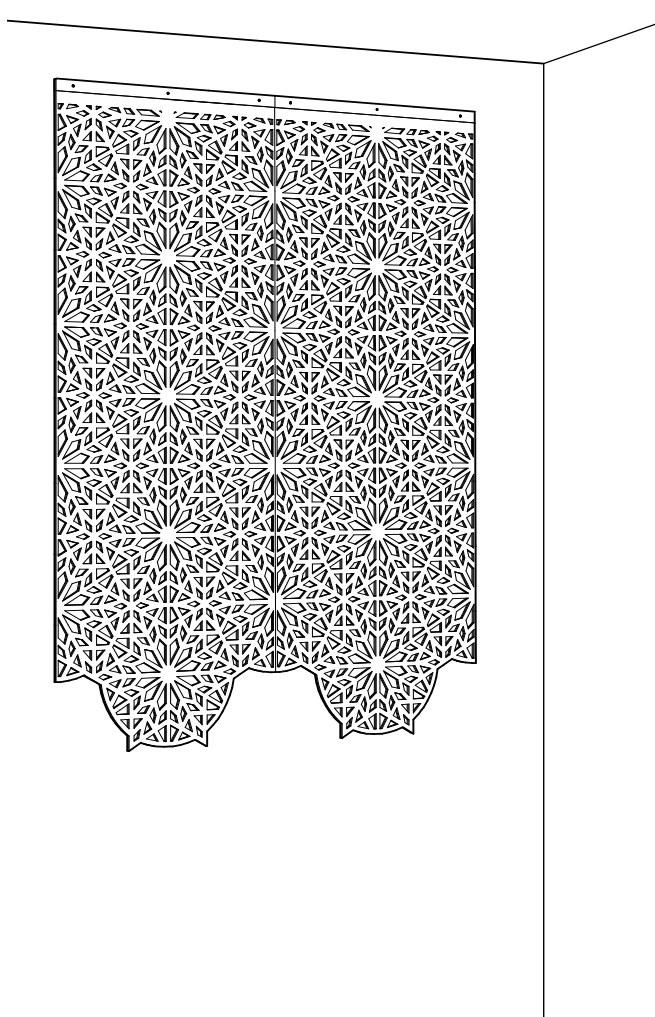
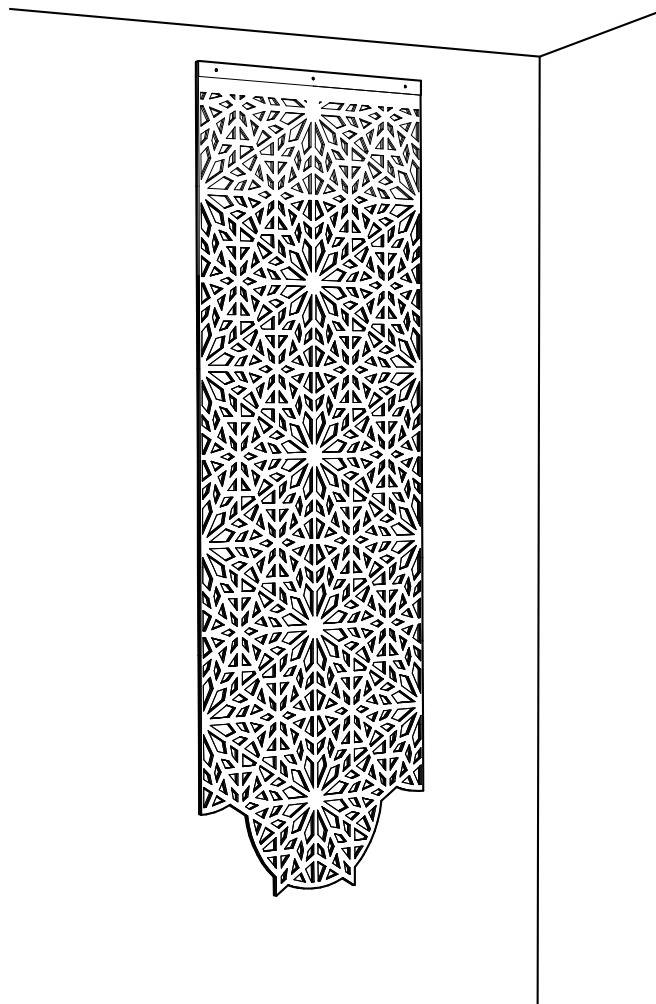

Profile black or white

3 screws 4x60 mm per set

3 cover caps per set, black or white, depending on color of profile

6 distance holders: 3 x 3 mm and 3 x 7,5 mm per set

BuzziFalls Rail Suspended

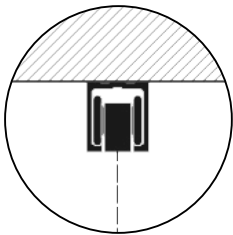
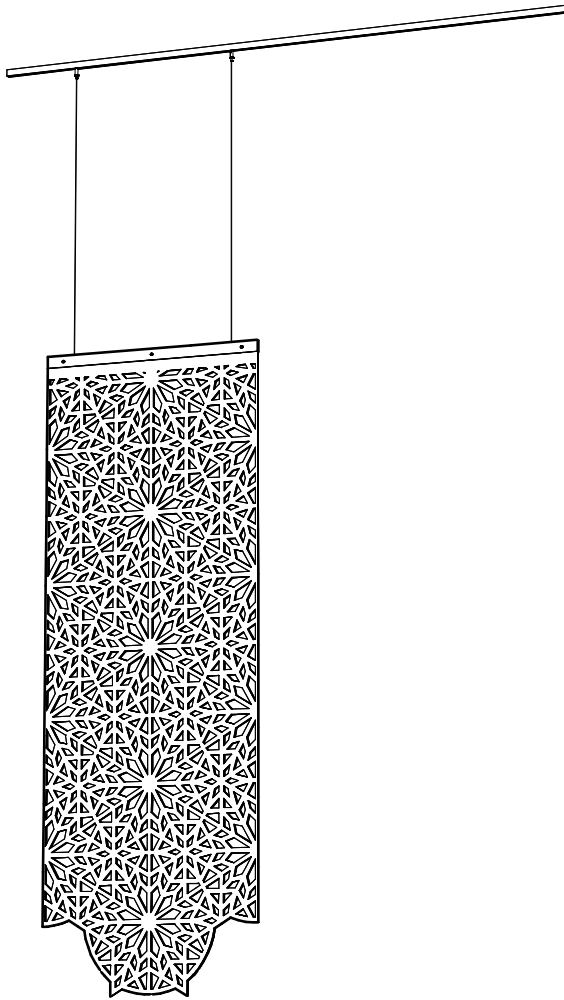

Rail black or white
L: 3,20 m | 125.98"

Profile black or white

Black or alu colored cable
L 200 or 500 cm,
Ø 1,5 mm
L 78.74" or 196.85",
Ø 0.06"

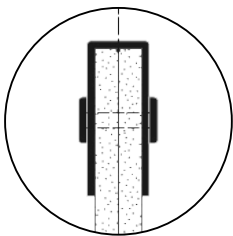

BuzziFalls Rail Mounted

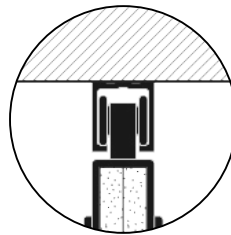
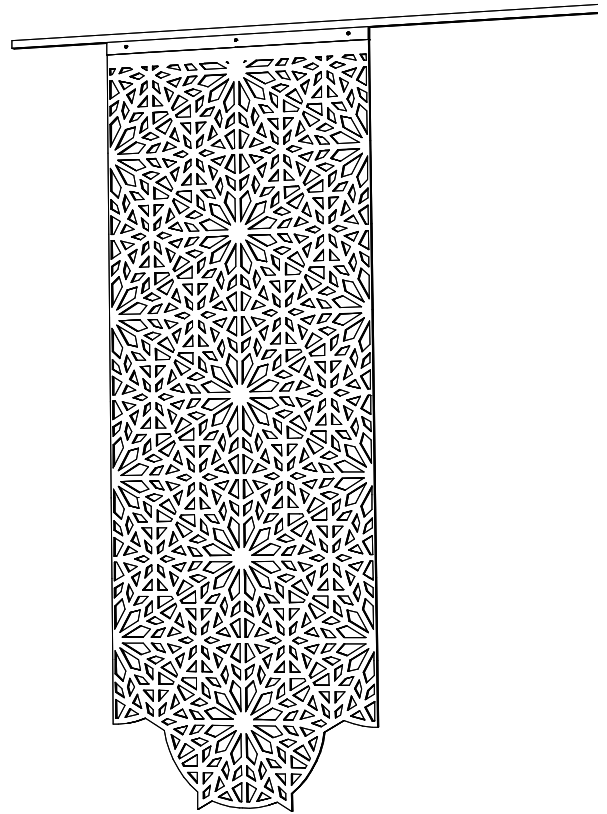

Rail black or white
L 3,20 m | 125.98"

Profile black or white

Option: Rail

The rail can be extended by buying a extra rail

BuzziFalls Rail Suspended

Profile black or white

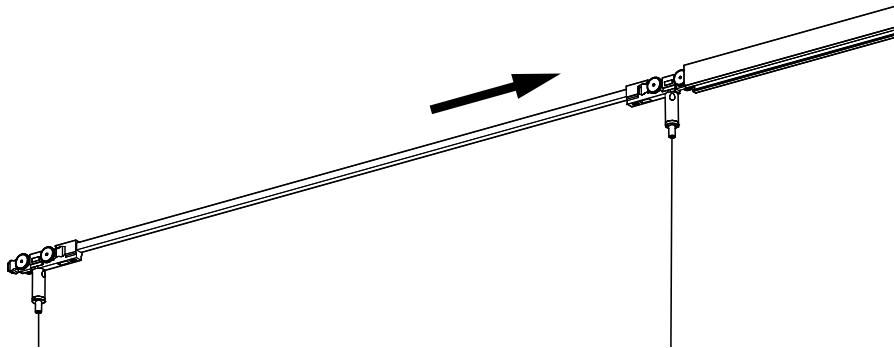

BuzziFalls Rail Mounted

Profile black or white

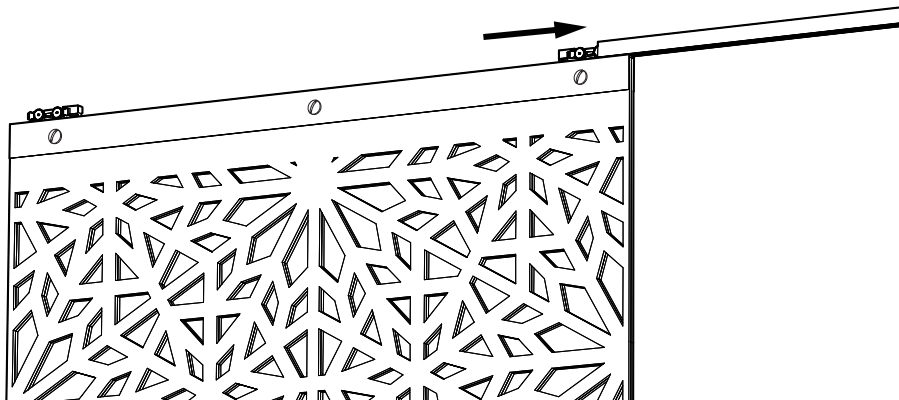

Rail

Black or white, L 3,20 m | 125.98".

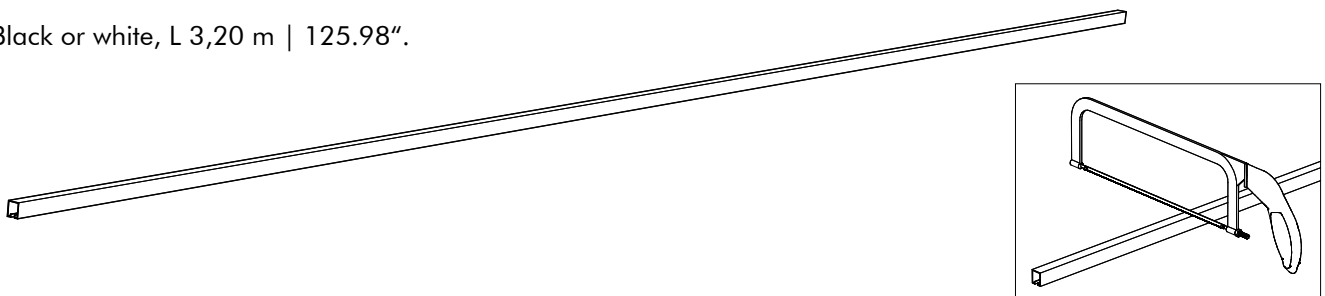

End cap

End cap black or white included

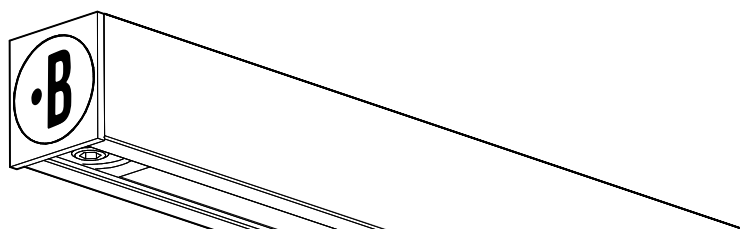

Dimensions

Falls Felt

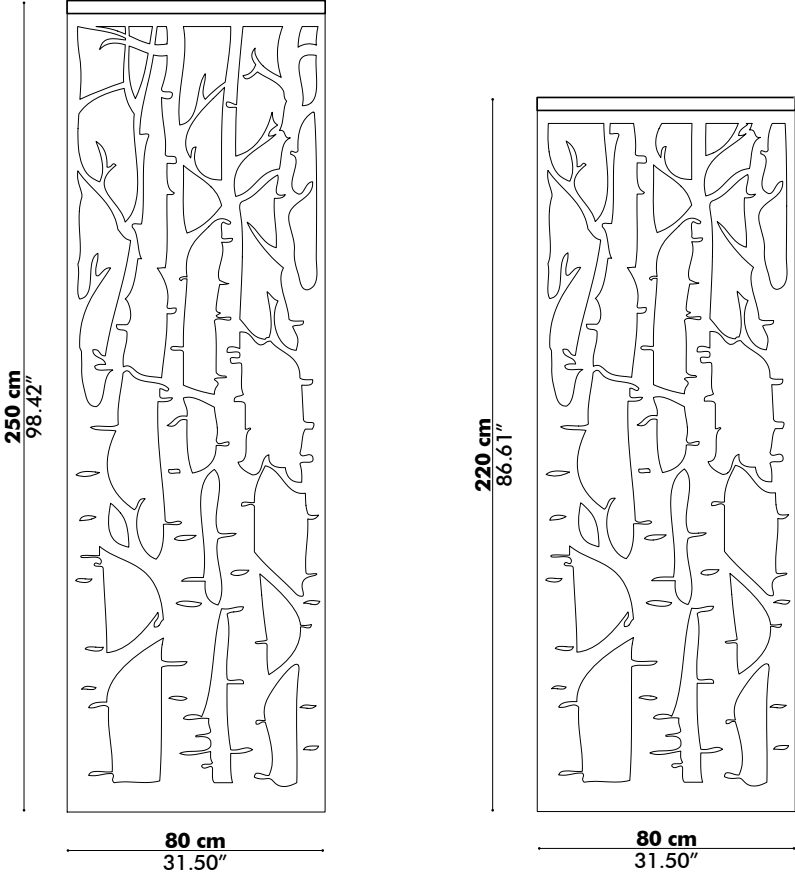

Metal Profile

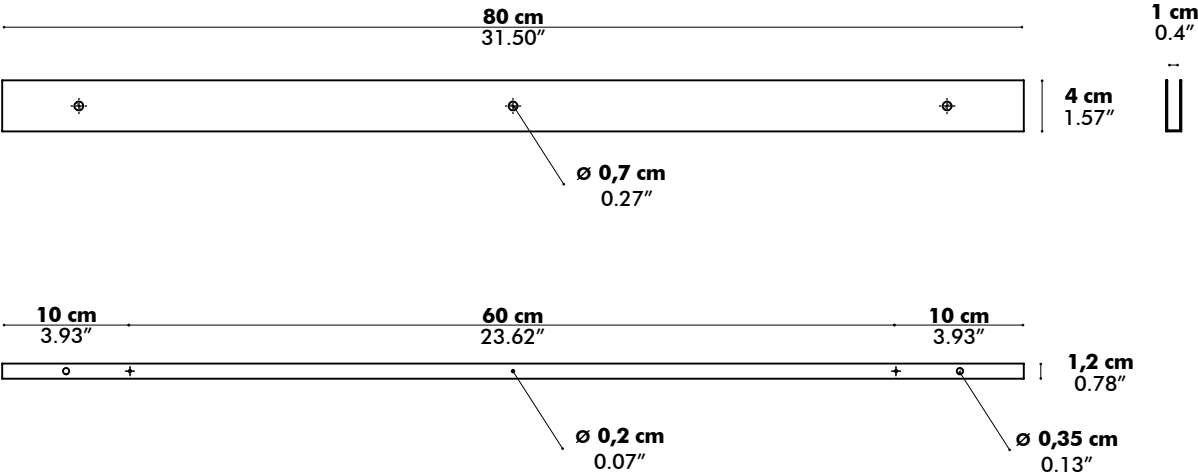

500 gr | 1.10 lbs

Alu Rail

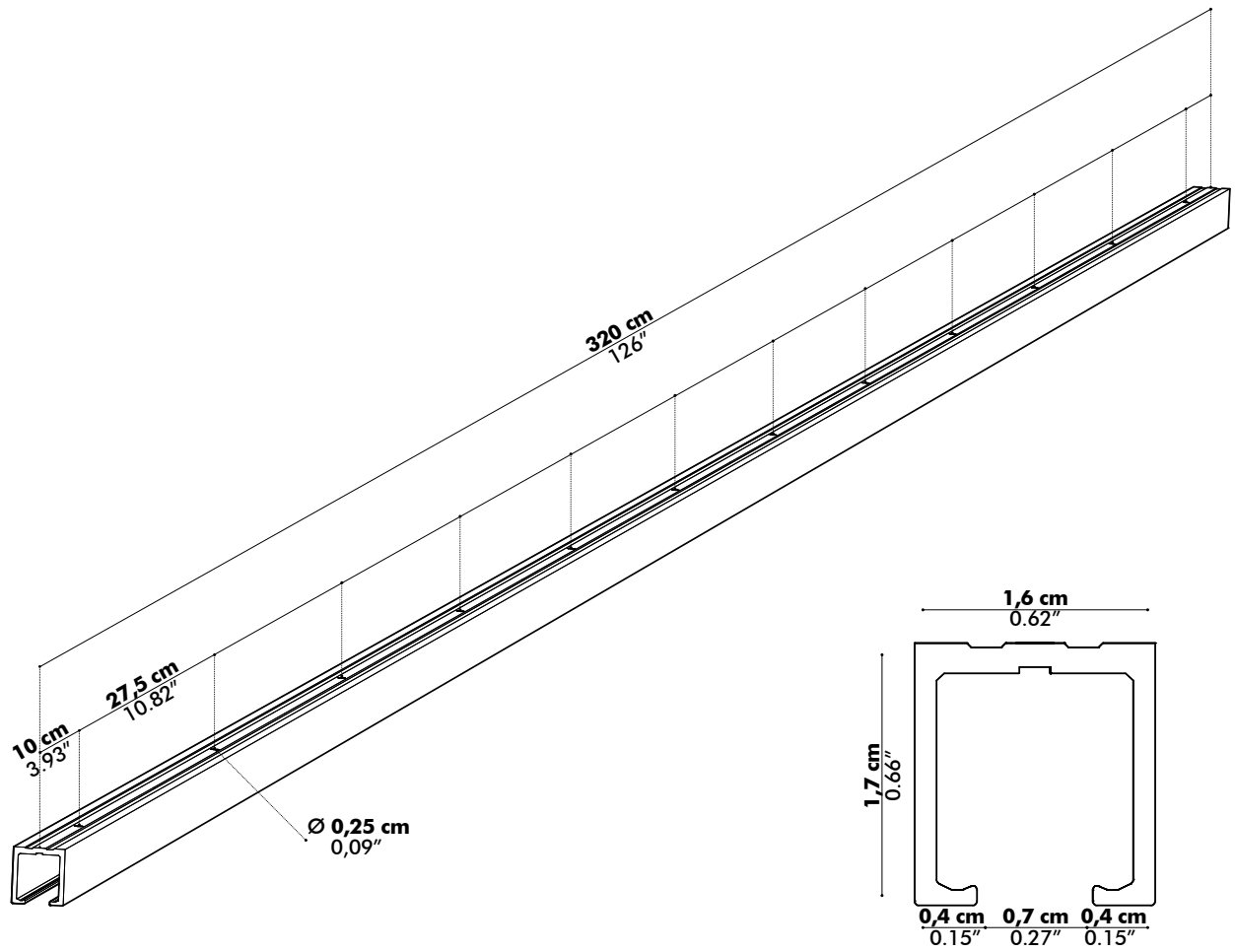

Acoustics

BuzziFalls Alhambra | Birch | Plain

Equivalent sound absorption area in m² per object

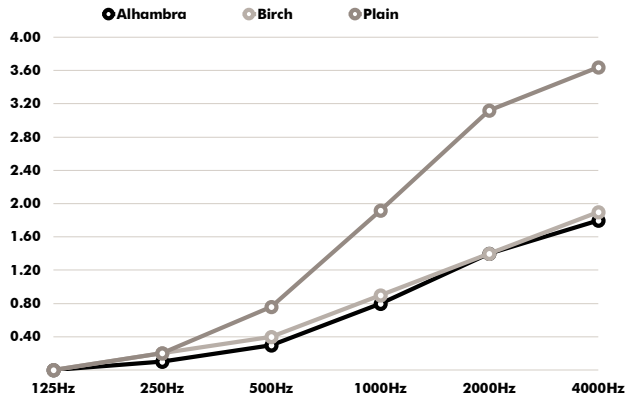

Hz	Alhambra Aeq/m ²	Birch Aeq/m ²	Plain Aeq/m ²
125	0.00	0.00	0.04
250	0.10	0.20	0.20
500	0.30	0.40	0.76
1000	0.80	0.90	1.92
2000	1.40	1.40	3.12
4000	1.80	1.90	3.64

