

BuzziMilk
Stool

asset
space becomes place

BuzziMilk

product specification sheet

This documents contains technical information about the BuzziMilk Stool, Counter, Bar, Bench, Stool All Wood, Side Table, Side Table Large, Table

·BUZZI
SPACE

www.buzzi.space



A classic milk stool





This rustic-meets-modern take on the old farmhouse favorite would even make your grandma feel nostalgic. BuzziMilk is a sturdy little stool inspired by elements not usually found in a standard office space. Its goal? Create a warm and homey feeling at work. BuzziMilk has four legs and an upholstered seat for a softer experience. Select from a variety of wood finishes and make it your own by pairing with one of our many BuzziSpace fabrics. Looking for a pure wood stool? BuzziMilk Stool Allwood is pure simplicity and strong design.

A versatile little table

The BuzziMilk base has inspired the handy BuzziMilk Tables. They can be grouped together to create a series of coffee or side tables, or used independently. Like the BuzziMilk design, multiple size and color options are possible.

Design by Alain Gilles

General

-  BuzziMilk Stool, Counter, Bar, Bench, Stool All Wood, Side Table, Side Table Large, Table
-  Frame: Wood
-  Dry usage
-  Assembled

Content

Configurations	3
Components	7
Fabrics	8
Finishes	11
Dimensions	12

Configurations

BuzziMilk Stool

📌 Stool

Frame in Ash Natural, Ash Black Stained, Ash White Wash, Walnut, Oak, Ash Lacquered White



Filling in C43170 foam

Seat upholstered in Fabric, Trevira CS+ | CS, Revive 1, Clara 2, Remix 3, Velvet, Hero 2, Tonus 4, Memory 2 or Leather Vegetal (Stitching is required for leather)



Stool: Ø 39 cm H 47,5 cm
 Ø 15.35" H 18.70"



Stool: ± 5,9 kg | ± 13.01 lbs
Max. weight capacity: 100 kg | 220.46 lbs

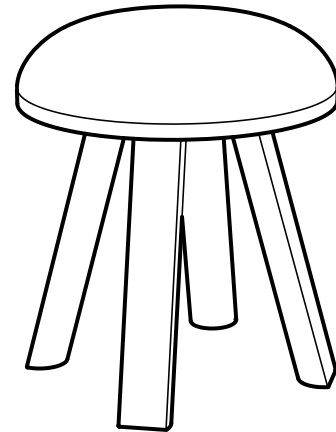

BuzziMilk Counter

📌 Counter

Frame in Ash Natural, Ash Black Stained, Ash White Wash, Walnut, Oak, Ash Lacquered White

Foot support in black lacquered metal.



Filling in C43170 foam

Seat upholstered in Fabric, Trevira CS+ | CS, Revive 1, Clara 2, Remix 3, Velvet, Hero 2, Tonus 4, Memory 2 or Leather Vegetal (Stitching is required for leather)



Counter: Ø 39 cm H 68 cm
 Ø 15.35" H 26.77"



Counter: ± 7,2 kg | ± 13.01 lbs
Max. weight capacity: 100 kg | 220.46 lbs

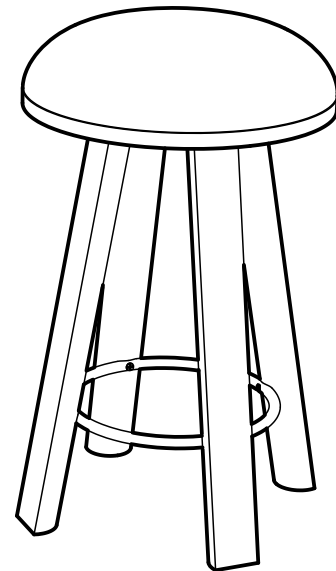

BuzziMilk Bar

📍 Bar

Frame in Ash Natural, Ash Black Stained,
Ash White Wash, Walnut, Oak,
Ash Lacquered White

Foot support in black lacquered metal.



Filling in C43170 foam

Seat upholstered in Fabric, Trevira CS+ | CS,
Revive 1, Clara 2, Remix 3, Velvet, Hero 2,
Tonus 4, Memory 2 or Leather Vegetal (Stitching
is required for leather)



Bar: Ø 39 cm H 78 cm
 Ø 15.35" H 30.71"



Bar: ± 7,8 kg | ± 17.20 lbs
Max. weight capacity: 100 kg | 220.46 lbs

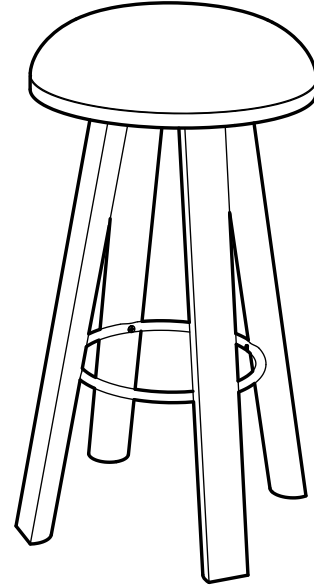

BuzziMilk Bench

📍 Bench

Frame in Ash Natural, Ash Black Stained,
Ash White Wash, Walnut, Oak,
Ash Lacquered White



Filling in C43170 foam

Seat upholstered in Fabric, Trevira CS+ | CS,
Revive 1, Clara 2, Remix 3, Velvet, Hero 2,
Tonus 4, Memory 2, Leather Vegetal (Stitching is
required for leather)



Bench: W 39 cm L 119 cm H 48 cm
 W 15.35" L 46.85" H 18.89"



Bench: ± 14,6 kg | ± 32.19 lbs
Max. weight capacity: 150 kg | 330.69 lbs

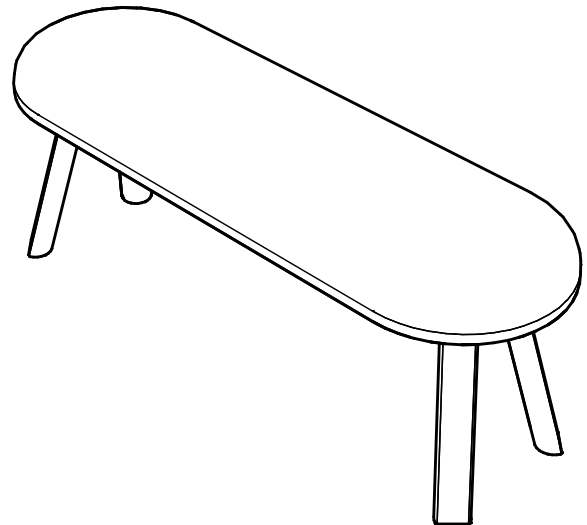

BuzziMilk Stool All Wood

📍 Stool All Wood

🌲 Frame in Ash Natural, Ash Black Stained,
Ash White Wash, Walnut, Oak,
Ash Lacquered White

✂ Stool : Ø 39 cm H 43 cm
 Ø 15.35" H 16.93"

⚖ Stool: ± 6,5 kg | 14.33 lbs
Max. weight capacity: 100 kg | 220.46 lbs

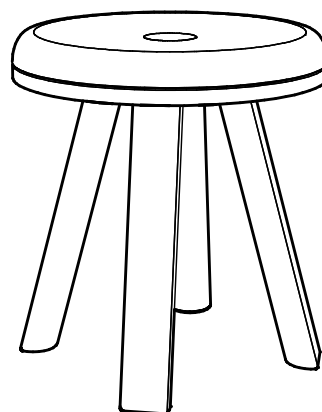

BuzziMilk Side Table

Side Table

Frame in Ash Natural, Ash Black Stained,
Ash White Wash, Walnut, Oak

Ø 39 cm H 39 cm
Ø 15.35" H 15.35"

Side Table: ± 4,1 kg | ± 9.04 lbs
Max. weight capacity: 100 kg | 220.46 lbs

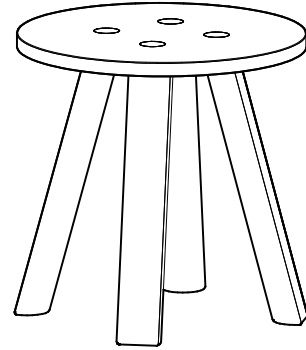

BuzziMilk Side Table Large

Side Table Large

Frame in Ash Natural, Ash Black Stained,
Ash White Wash, Walnut, Oak

W 39 cm L 119 cm H 39 cm
W 15.35" L 46.85" H 15.35"

Side Table Large : ± 8,1 kg | ± 17.86 lbs
Max. weight capacity: 50 kg | 110.23 lbs

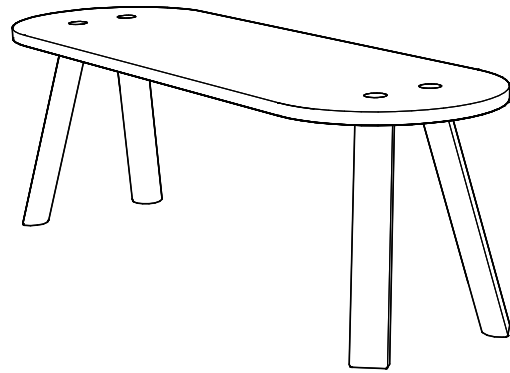

BuzziMilk Table

Table

Frame in Ash Natural, Ash Black Stained,
Ash White Wash, Walnut, Oak

Ø 100 cm H 73,5 cm
Ø 39.37" H 28.94"

Table: 36 kg | 97.37 lbs

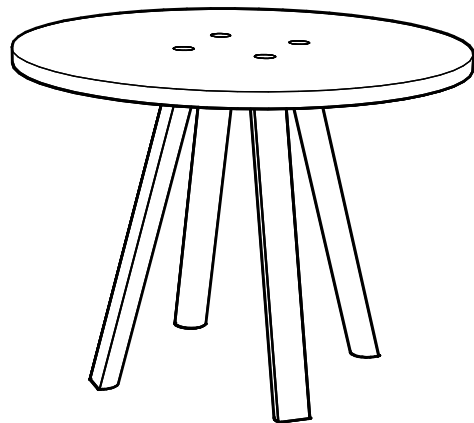

Components



BuzziMilk has Felt or Plastic inserts



Black powder coated metal connection

Fabrics

Fabric (45 colors)

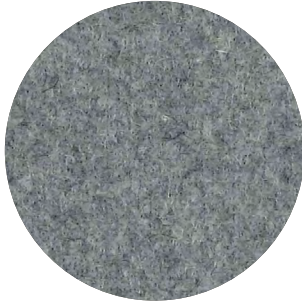

Category A

Composition 70% Recycled Wool, 25% Recycled Polyacryl,
5% Recycled Other Fabrics

Weight 405 g/m² | 11.94 oz/yd²

Abrasion resistance 40.000 Martindale, 50,000 Wyzenbeek

Flammability EU: EN 1021.1/2006 | BS EN 1021.1/2006 (cigarette).
EN 1021.2/2006 | BS EN 1021.2/2006 (match)
USA: CAL TB 117 | ASTM E84 CLASS A

Fastness to light EU: 4 | USA 4

Fastness to rubbing EU: Wet 3-4 | Dry 4-5

Fastness to crocking USA: Wet 5 | Dry 5



Trevira CS+ | CS (47 colors)

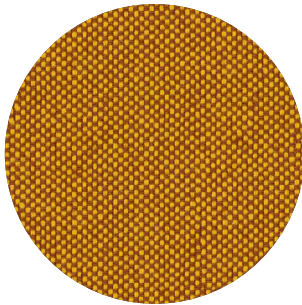

Category A

Weight 420 g/m² | 12.39 oz/yd²

Composition 100% Polyester, Trevira CS

Abrasion resistance 100.000 Martindale, 90,000 Wyzenbeek

Flammability BS 5852 part II: CRIB 5 | BS 7176 Medium Hazard
USA: CAL TB 117 | M1 | B1 | EN 1021/1-2 | C1 |
IMO Res. A652 (16)

Fastness to light EU: 6 | USA 5

Fastness to rubbing EU: Wet 4-5 | Dry 4-5

Fastness to crocking USA: Wet 5 | Dry 5



Revive 1 (25 colors)

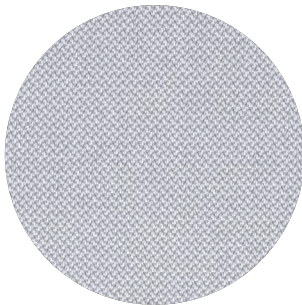

Category A

Composition 100% recycled polyester FR

Weight 430 g/lin.m

Abrasion resistance 60.000 Martindale rubs, EN ISO 12947

Flammability EN 1021-1/2 | DIN 4102 B1 | Önorm B1/Q1
UNI 9175 1IM | US Cal. Tech. Bull. 117
IMO A.652 (16)

Fastness to light Note 5-7, ISO 105-B02

Fastness to rubbing (ISO) dry 5, wet 4-5

Pilling Note 4-5, EN ISO 12945



kvadrat

Velvet (12 colors)

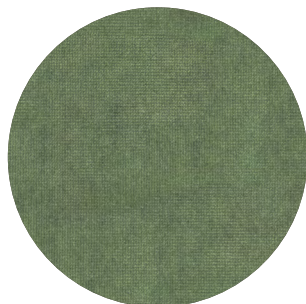

Category B
Composition 100% PES
Weight 375 g/m² | 11.06 oz/yd²
Abrasion resistance > 100.000 Martindale
Fastness to light EU: 4-5
Fastness to rubbing EU: Wet 4 | Dry 4-5
Pilling EU: 4-5

Clara 2 (24 colors)

kvadrat

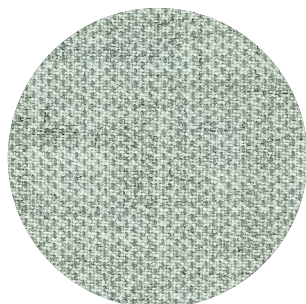

Category B
Composition 92% new wool, 8% nylon
Weight 400 g/lin.m
Abrasion resistance 80.000 Martindale rubs, EN ISO 12947
Flammability EN 1021-1/2 | BS 5852, ignition source 2-3 | DIN 4102 B2
NF D 60 013 | UNI 9175 1IM | US Cal. Tech. Bull. 117, Sec. E
NFPA 260 | IMO A.652(16)
Fastness to light Note 5-7, ISO 105-B02
Fastness to rubbing (ISO) dry 4-5, wet 4
Pilling Note 4, EN ISO 12945



Remix 3 (73 colors)

kvadrat



Category B
Composition 90% new wool, 10% nylon
Weight 415 g/lin.m
Abrasion resistance 100.000 Martindale rubs, EN ISO 12947
Flammability EN 1021-1/2 | BS 5852 part 1
Önorm B1/Q1 | NF D 60 013 | UNI 9175, 1IM
AS/NZS 1530.3 | Cal. Tech. Bull. 117-2013
NFPA 260 | IMO FTP Code 2010:Part 8
Fastness to light Note 5-7, ISO 105-B02
Fastness to rubbing (ISO) dry 4-5, wet 4
Pilling Note 4, EN ISO 12945



Hero 2 (33 colors)

kvadrat

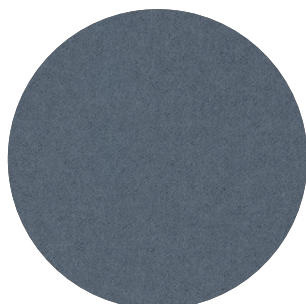

Category C
Composition 97% new wool, 3% nylon
Weight 580 g/lin.m
Abrasion resistance 45.000 Martindale rubs, EN ISO 12947
Flammability EN 1021-1/2 | DIN 4102 B2 | NF D 60 013
UNI 9175 1IM | US Cal. Bull. 117-2013 | NFPA 260
IMO A.652 (16)
Fastness to light Note 5-6, ISO 105-B02
Fastness to rubbing (ISO) dry 4-5, wet 4-5
Pilling Note 3-4, EN ISO 12945



Tonus 4 (47 colors)

kvadrat



Category D

Composition 90% new wool, 10% Helanca

Weight 665 g/lin.m

Abrasion resistance 100.000 Martindale rubs, EN ISO 12947

Flammability EN 1021-1/2 | BS 5852 part 1 | DIN 4102 B2

Önorm B1/Q1 | NF D 60 013 | UNI 9175 11M

US Cal. Bull. 117-2013 | NFPA 260 | IMO A.652 (16)

Fastness to light Note 5-7, ISO 105-B02

Fastness to rubbing (ISO) dry 3-5, wet 3-5

Pilling Note 3, EN ISO 12945



Memory 2 (20 colors)

kvadrat

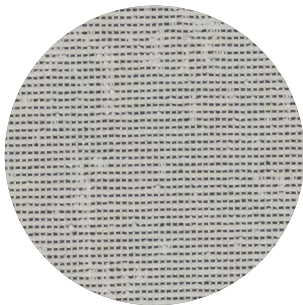

Category E

Composition 100% Trevira CS

Weight 700 g/lin.m

Abrasion resistance

35.000 rubs acc. to the Martindale method, EN ISO 12947

Flammability EN 1021-1/2 | DIN 4102 B1 | Önorm B1/Q1

NF D 60 013 | NF P 92 507 M1 | UNI 9175 11M

UNI 9177 classe 1 | US Cal. Tech. Bull. 117

IMO A.652 (16)

Fastness to light Note 5-8, ISO 105-B02

Fastness to rubbing (ISO) dry 4-5, wet 4-5

Pilling Note 4, EN ISO 12945



Leather Vegetal (2 colors)



Raw material Scandinavian Bullhides

Surface Pure Aniline

Flammability EU: EN 1021.1 - BS5852 PART 1 (cigarette)

EN 1021.2 - BS5852 PART 1 (match)

USA: CAL TB 117

Fastness to light EU: 3 Blue Scale (72h exposition)

Fastness to rubbing EU: Wet: 20 cycles/3 | Dry: 50 cycles/3

Sweat: 20 cycles/3

Streight Tear resistance: >20N or 10N/mm thickness

Tensile: >20N/mmq

Elongation: 40-70%

Finishes

Wood

for Base and Tabletop



Ash Natural



Ash Black Stained



Ash White Wash

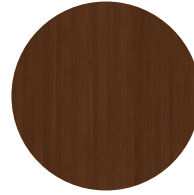

Walnut



Oak



Ash Lacquered
White*

* Not available for Side Table, Side Table Large, Table

Dimensions

Stool

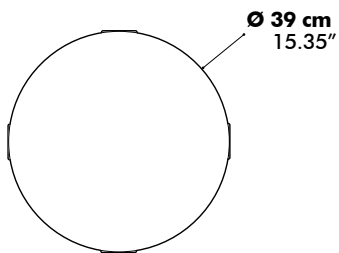
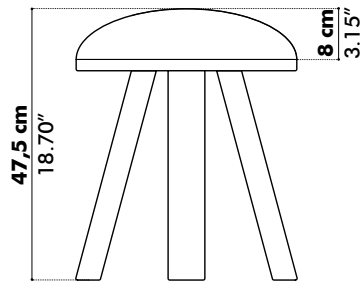

Counter

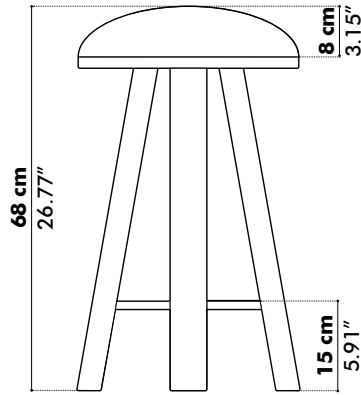

Bar

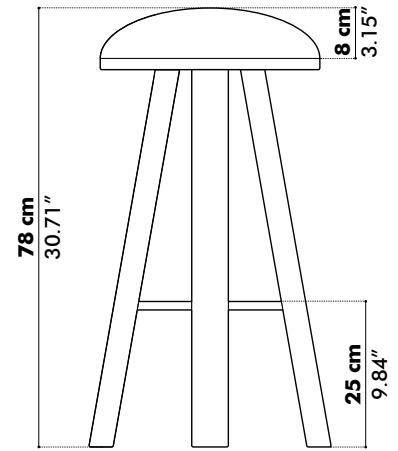

Bench

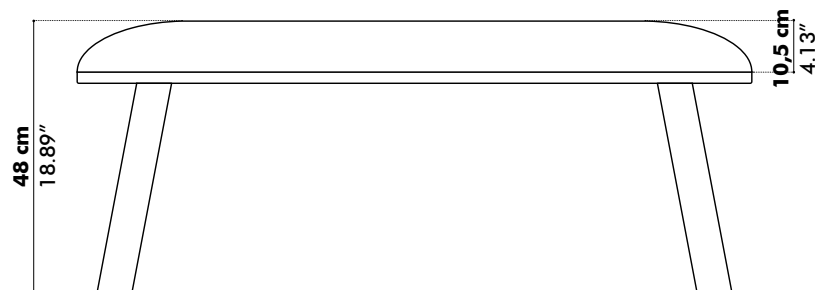
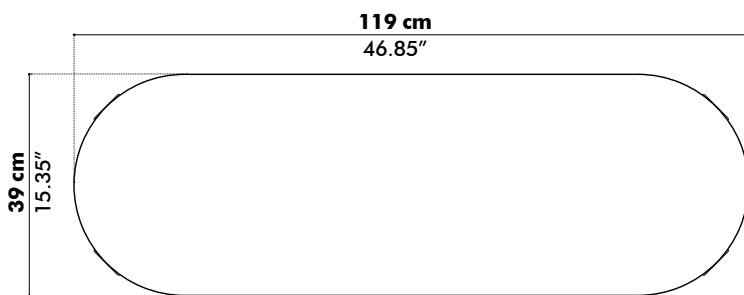

Stool All Wood

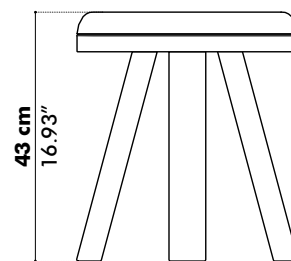
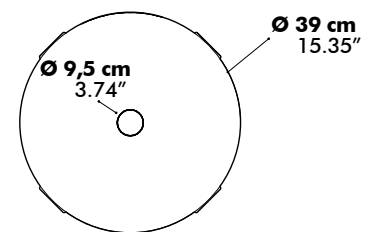

Side Table

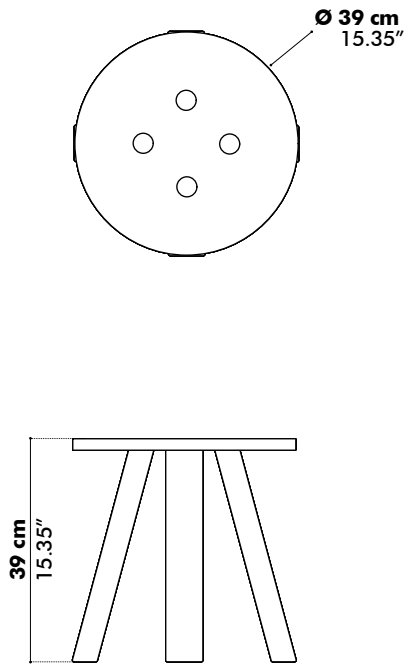

Side Table Large

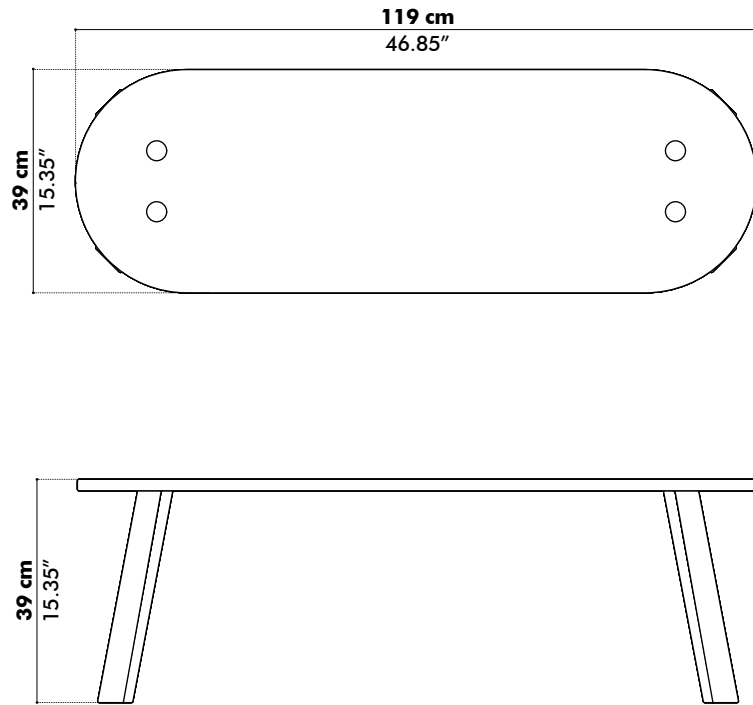

Table

