

**BuzziTile**  
Soundabsorbing Wall Panel

**asset**  
space becomes place



---

# BuzziTile

## Product Specification Sheet

---

This document contains technical information about the BuzziTile

---



[www.buzzi.space](http://www.buzzi.space)

## Graphical acoustic wall element

The BuzziTile turns any blind wall into a must see. By using multiple Tiles and playing with different colours you create a highly graphical feature on the wall. Let your creativity do the work.

BuzziTile is offered in flat and different 3d pattern and can be finished off in different fabrics.

The BuzziTile family is a perfect solution for attenuating sound.

Design by BuzziSpace Studio

## General

- Flat | 3D  
BuzziTile Square L | Square XL | Metro | Hexa | Penta | Triangle L | Triangle XL
- Filling: acoustic foam  
Cover: Fabric, Trevira CS + |CS, Revive 1, Clara 2, Remix 3, Hero, Tonus 4, Memory 2

---

## Acoustics



Absorption



Diffusion



Mid tone



High tone

---

## Certifications



---

## Content

Composition	3
Configurations	3
Patterns	5
Fabrics	9
Dimensions	12
Acoustics	16

# Composition

---

## Back in Felt | Tape

6 mm | 0.24" BuzziFelt  
acoustic foam  
layer of fabric  
self adhesive tape at the back

---

## Back in Wood | Tape

6 mm | 0.24" MDF  
acoustic foam  
layer of fabric  
self adhesive tape at the back

---

## Back in Wood | Powermagnets

6 mm | 0.24" MDF  
acoustic foam  
layer of fabric  
powermagnets

## Note

Be sure wall surface is free of dirt, grease or any special paint finishes that could prevent the adhesive from adhering to wall surface.





Due to possible variation in dimension and density, we advise to install the tiles with felt backing at 0,5 mm - 1 cm | 0.20" - 0.39" distance from each other. For more precise applications, tiles with wooden back are advisable.

# Configurations

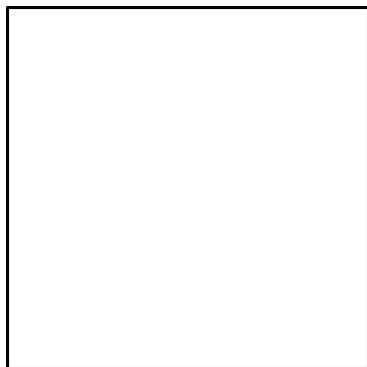
---

## BuzziTile Square L | XL



- Flat
-  3D: 1SQ, 4SQ, 25SQ, Arrow, Bee, Dune, Frost, Leaf, Radial, Rib, Spike, Waffle
-  Fabrics: Fabric, Trevira CS + |CS, Revive 1, Clara 2, Remix 3, Hero, Tonus 4, Memory 2
-  L: H 60 cm    W 60 cm  
          H 23.62"    W 23.62"
- XL: H 120 cm    W 120 cm  
              H 47.24"    W 47.24"
-  L: back in felt:    ± 1kg    |    ± 2.20 lbs  
                      back in wood: ± 2 kg    |    ± 4.41 lbs
- XL: back in felt:    ± 3,5 kg |    ± 6.61 lbs  
                      back in wood: ± 8 kg    |    ± 17.64 lbs
- Flat: - back in wood | no stitch | self adhesive tape or powermagnets
- 3D: - back in felt: with or without stitch + self adhesive tape  
          (no stitch for Radial | Waffle | Leaf | Bee)
- ... - back in wood: no stitch + self adhesive tape or  
          no stitch + powermagnets

---

## BuzziTile Metro

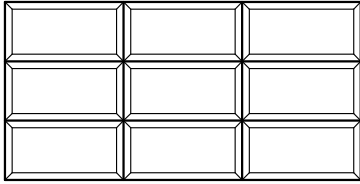

- 🔪 Flat  
3D: Metro
- 🌲 Fabrics: Fabric, Trevira CS + |CS, Revive 1, Clara 2, Remix 3, Hero, Tonus 4, Memory 2
- ✂ H 40 cm    W 80 cm  
H 15.75"    W 31.50"
- ⚖ Back in felt:    ± 1kg | ± 2.20 lbs  
Back in wood:    ± 2 kg | ± 4.41 lbs
- 3D: - back in felt: with or without stitch + self adhesive tape
- ... - back in wood: no stitch + self adhesive tape or  
no stitch + powermagnets

---

## BuzziTile Hexa

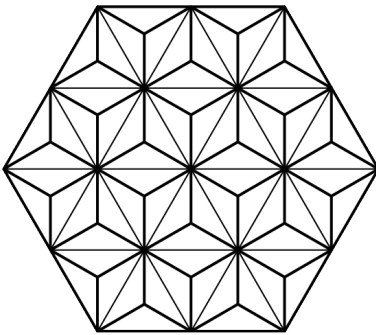

- 🔪 3D: Bee | Frost | Spike | Why
- 🌲 Fabrics: Fabric, Trevira CS + |CS, Revive 1, Clara 2, Remix 3, Hero, Tonus 4, Memory 2
- ✂ H 60 cm    W 69,3 cm  
H 23.62"    W 27.28"
- ⚖ Back in felt:    ± 0,75 kg | ± 1.65 lbs  
Back in wood:    ± 1,75 kg | ± 3.86 lbs
- 3D: - back in felt: no stitch + self adhesive tape
- ... - back in wood: no stitch + self adhesive tape or  
no stitch + powermagnets

---

## BuzziTile Penta

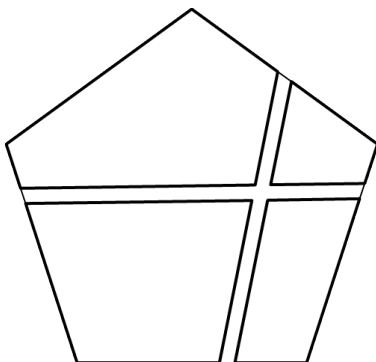

- 🔪 3D: Kite
- 🌲 Fabrics: Fabric, Trevira CS + |CS, Revive 1, Clara 2, Remix 3, Hero, Tonus 4, Memory 2
- ✂ H 60 cm    W 63 cm  
H 23.62"    W 24.80"
- ⚖ Back in felt:    ± 0,70 kg | ± 1.54 lbs  
Back in wood:    ± 1,50 kg | ± 3.31 lbs
- 3D: - back in felt: no stitch + self adhesive tape
- ... - back in wood: no stitch + self adhesive tape or  
no stitch + powermagnets

# BuzziTile Triangle L | XL

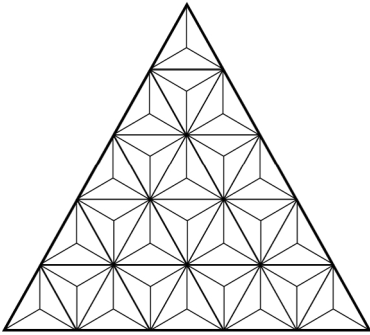

Flat  
3D: Spike

Fabrics: Fabric, Trevira CS + |CS, Revive 1, Clara 2, Remix 3, Hero, Tonus 4, Memory 2

L: H 52 cm W 60 cm  
H 20.47" W 23.62"  
XL: H 104 cm W 120 cm  
H 40.94" W 47.24

L: Back in felt: ± 0,5kg | ± 1.10 lbs  
Back in wood: ± 1 kg | ± 2.20 lbs  
XL: Back in felt: ± 1,5kg | ± 3.31 lbs  
Back in wood: ± 4 kg | ± 8.82 lbs

Flat: - back in wood | no stitch | self adhesive tape or powermagnets  
3D: - back in felt: no stitch + self adhesive tape  
- back in wood: no stitch + self adhesive tape or  
no stitch + powermagnets

## Patterns

### BuzziTile Square L

**Flat**

H 60 cm W 60 cm  
H 23.62" W 23.62"

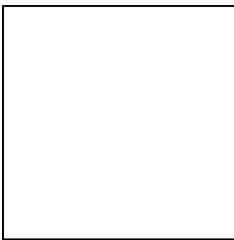

**1SQ**

H 60 cm W 60 cm  
H 23.62" W 23.62"

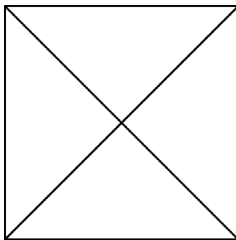

**4SQ**

H 60 cm W 60 cm  
H 23.62" W 23.62"

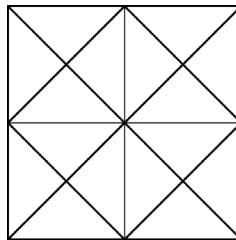

**25SQ**

H 60 cm W 60 cm  
H 23.62" W 23.62"

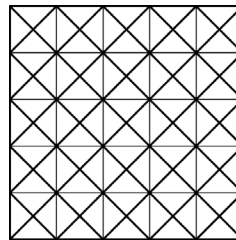

**Arrow**

H 60 cm W 60 cm  
H 23.62" W 23.62"

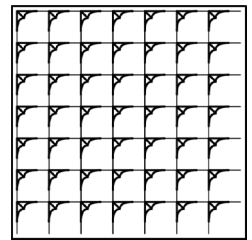

**Bee**

H 60 cm W 60 cm  
H 23.62" W 23.62"

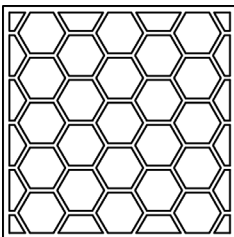

**Dune**

H 60 cm W 60 cm  
H 23.62" W 23.62"

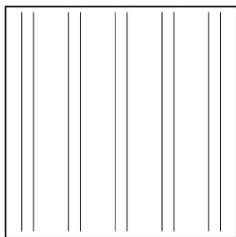

**Frost**

H 60 cm W 60 cm  
H 23.62" W 23.62"

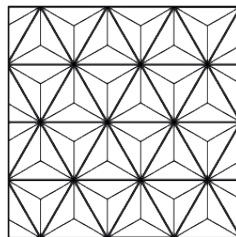

**Leaf**

H 60 cm W 60 cm  
H 23.62" W 23.62"

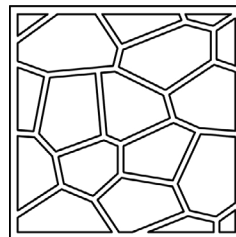

**Radial**

H 60 cm W 60 cm  
H 23.62" W 23.62"

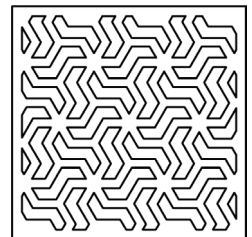

**Rib**

H 60 cm W 60 cm  
H 23.62" W 23.62"

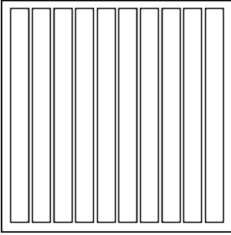

**Spike**

H 60 cm W 60 cm  
H 23.62" W 23.62"

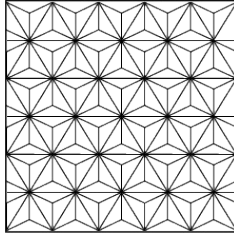

**Waffle**

H 60 cm W 60 cm  
H 23.62" W 23.62"

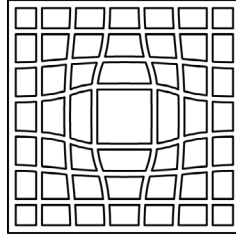

---

**BuzziTile Square XL**

**Flat**

H 120 cm W 120 cm  
H 47.24" W 47.24"



**4SQ**

H 120 cm W 120 cm  
H 47.24" W 47.24"

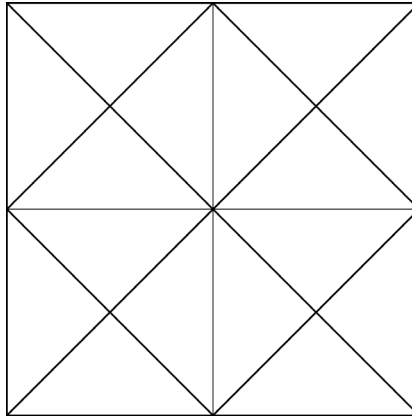

**16SQ**

H 120 cm W 120 cm  
H 47.24" W 47.24"

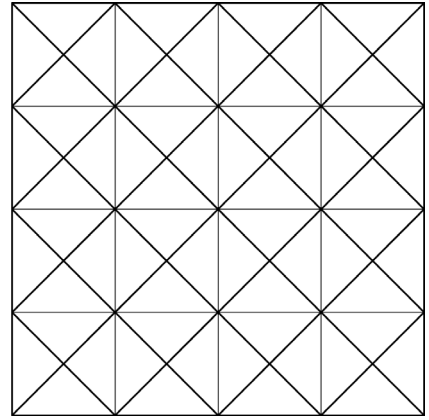

**Arrow**

H 120 cm W 120 cm  
H 47.24" W 47.24"

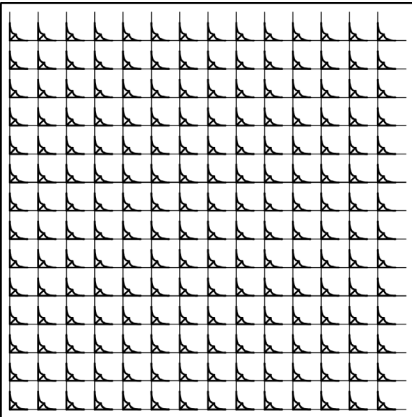

**Bee**

H 120 cm W 120 cm  
H 47.24" W 47.24"

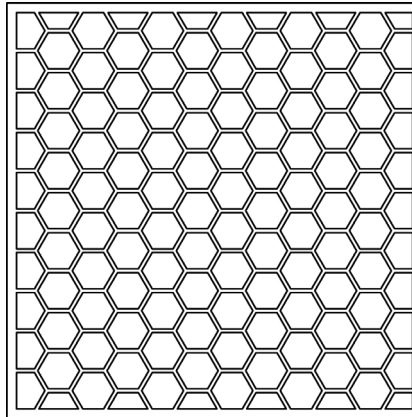

**Dune**

H 120 cm W 120 cm  
H 47.24" W 47.24"

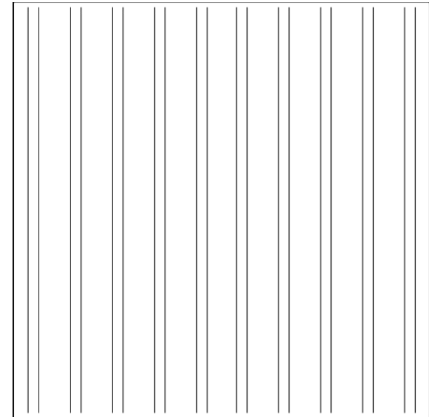

**Frost**

H 120 cm W 120 cm  
H 47.24" W 47.24"

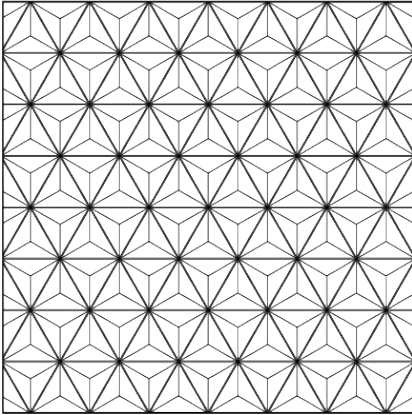

**Leaf**

H 120 cm W 120 cm  
H 47.24" W 47.24"

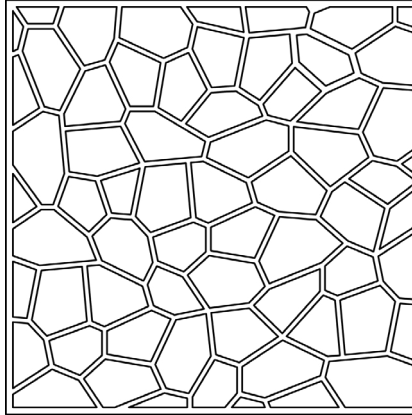

**Radial**

H 120 cm W 120 cm  
H 47.24" W 47.24"

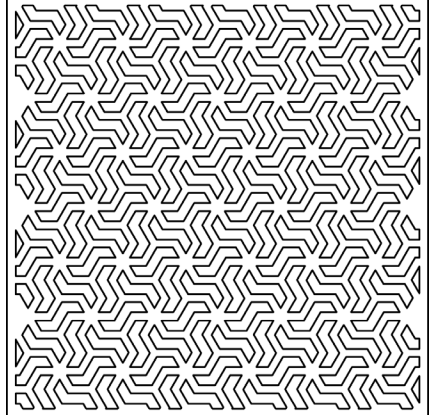

**Rib**

H 120 cm W 120 cm  
H 47.24" W 47.24"

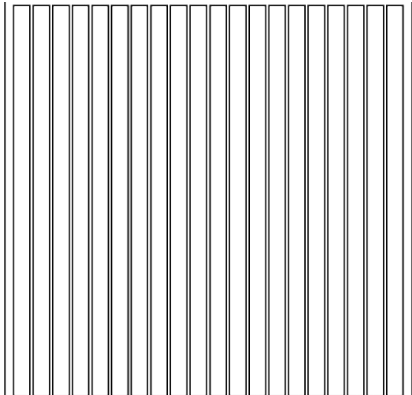

**Spike**

H 120 cm W 120 cm  
H 47.24" W 47.24"

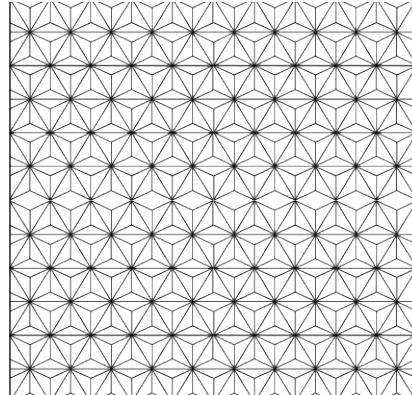

**Waffle**

H 120 cm W 120 cm  
H 47.24" W 47.24"

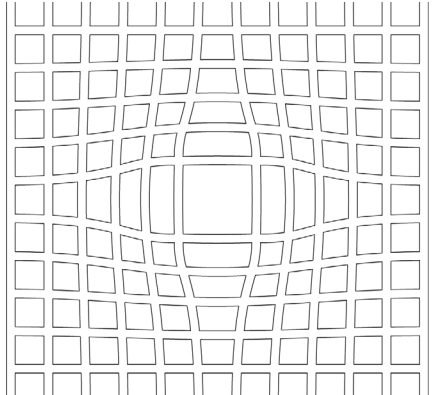

---

**BuzziTile Metro**

**Flat**

H 40 cm W 80 cm  
H 15.75" W 31.50"

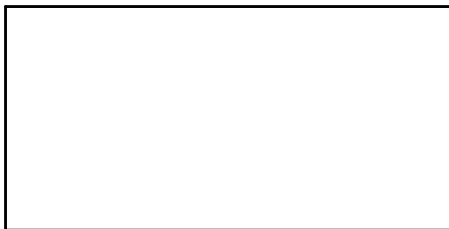

**3D Metro**

H 40 cm W 80 cm  
H 15.75" W 31.50"

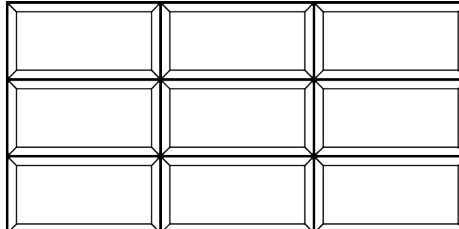



---

## BuzziTile Hexa

### Bee

H 60 cm W 69,3 cm  
H 23.62" W 27.28"

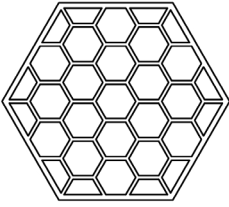

### Frost

H 60 cm W 69,3 cm  
H 23.62" W 27.28"

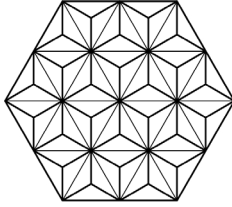

### Spike

H 60 cm W 69,3 cm  
H 23.62" W 27.28"

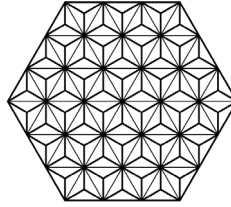

### Why

H 60 cm W 69,3 cm  
H 23.62" W 27.28"

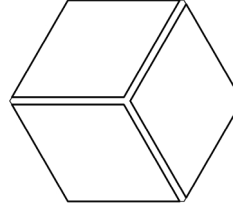

---

## BuzziTile Penta

### Kite

H 60 cm W 63 cm  
H 23.62" W 24.80"

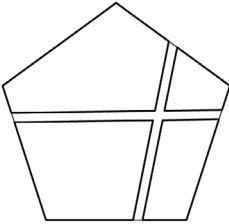

---

## BuzziTile Triangle L | XL

### Flat

W 60 cm H 52 cm  
W 23.62" H 20.47"

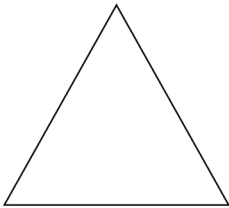

### Spike

W 60 cm H 52 cm  
W 23,62" H 20.47"

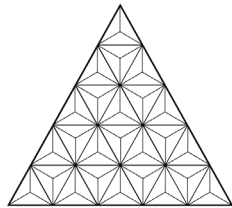

### Flat

W 120 cm H 104 cm  
W 47.24 H 40.94"

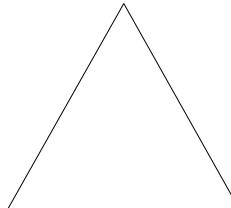

### Spike

W 120 cm H 104 cm  
W 47.24 H 40.94"

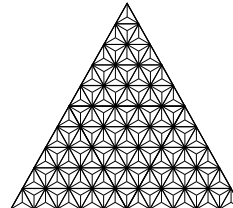

# Fabrics

## Fabric

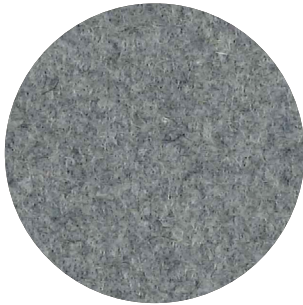

**Category A**

**Composition** 70% Recycled Wool, 25% Recycled Polyacryl,  
5% Recycled Other Fabrics

**Weight** 405 g/m<sup>2</sup> | 11.94 oz/yd<sup>2</sup>

**Abrasion resistance** 40.000 Martindale, 50,000 Wyzenbeek

**Flammability** EU: EN 1021.1/2006 | BS EN 1021.1/2006 (cigarette).  
EN 1021.2/2006 | BS EN 1021.2/2006 (match)  
USA: CAL TB 117 | ASTM E84 CLASS A

**Fastness to light** EU: 4 | USA 4

**Fastness to rubbing** EU: Wet 3-4 | Dry 4-5

**Fastness to crocking** USA: Wet 5 | Dry 5



## Trevira CS+ | CS

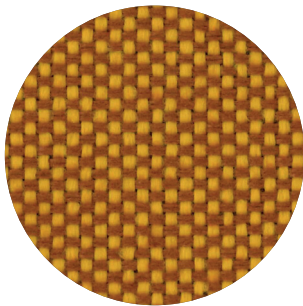

**Category A**

**Weight** 420 g/m<sup>2</sup> | 12.39 oz/yd<sup>2</sup>

**Composition** 100% Polyester, Trevira CS

**Abrasion resistance** 100.000 Martindale, 90,000 Wyzenbeek

**Flammability** BS 5852 part II: CRIB 5 | BS 7176 Medium Hazard  
USA: CAL TB 117 | M1 | B1 | EN 1021/1-2 | C1 |  
IMO Res. A652 (16)

**Fastness to light** EU: 6 | USA 5

**Fastness to rubbing** EU: Wet 4-5 | Dry 4-5

**Fastness to crocking** USA: Wet 5 | Dry 5



## Revive 1

kvadrat

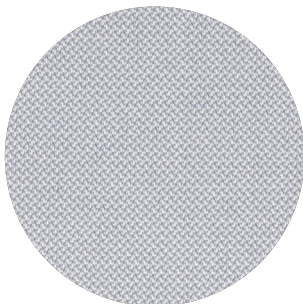

**Category A**

**Composition** 100% recycled polyester FR

**Weight** 430 g/lin.m

**Abrasion resistance** 60.000 Martindale rubs, EN ISO 12947

**Flammability** EN 1021-1/2 | DIN 4102 B1 | Önorm B1/Q1  
UNI 9175 1IM | US Cal. Tech. Bull. 117  
IMO A.652 (16)

**Fastness to light** Note 5-7, ISO 105-B02

**Fastness to rubbing** (ISO) dry 5, wet 4-5

**Pilling** Note 4-5, EN ISO 12945



## Clara 2

kvadrat

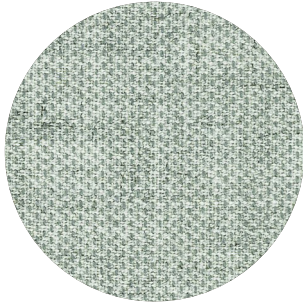

**Category B**

**Composition** 92% new wool, 8% nylon

**Weight** 400 g/lin.m

**Abrasion resistance** 80.000 Martindale rubs, EN ISO 12947

**Flammability** EN 1021-1/2 | BS 5852, ignition source 2-3 | DIN 4102 B2  
NF D 60 013 | UNI 9175 11M | US Cal. Tech. Bull. 117, Sec. E  
NFPA 260 | IMO A.652(16)

**Fastness to light** Note 5-7, ISO 105-B02

**Fastness to rubbing** (ISO) dry 4-5, wet 4

**Pilling** Note 4, EN ISO 12945



## Remix 3

kvadrat



**Category B**

**Composition** 90% new wool, 10% nylon

**Weight** 415 g/lin.m

**Abrasion resistance** 100.000 Martindale rubs, EN ISO 12947

**Flammability** EN 1021-1/2 | BS 5852 part 1  
Önorm B1/Q1 | NF D 60 013 | UNI 9175, 11M  
AS/NZS 1530.3 | Cal. Tech. Bull. 117-2013  
NFPA 260 | IMO FTP Code 2010:Part 8

**Fastness to light** Note 5-7, ISO 105-B02

**Fastness to rubbing** (ISO) dry 4-5, wet 4

**Pilling** Note 4, EN ISO 12945



## Hero

kvadrat

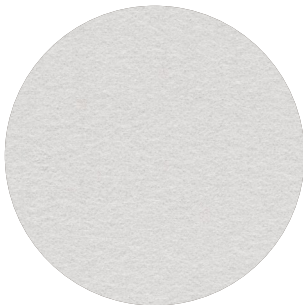

**Category C**

**Composition** 96% new wool, 4% nylon

**Weight** 580 g/lin.m

**Abrasion resistance** 45.000 Martindale rubs, EN ISO 12947

**Flammability** EN 1021-1/2 | DIN 4102 B2 | NF D 60 013  
UNI 9175 11M | US Cal. Bull. 117-2013 | NFPA 260  
IMO A.652 (16)

**Fastness to light** Note 5-6, ISO 105-B02

**Fastness to rubbing** (ISO) dry 4-5, wet 4-5

**Pilling** Note 3-4, EN ISO 12945



## Tonus 4

kvadrat



**Category D**

**Composition** 90% new wool, 10% Helanca

**Weight** 665 g/lin.m

**Abrasion resistance** 100.000 Martindale rubs, EN ISO 12947

**Flammability** EN 1021-1/2 | BS 5852 part 1 | DIN 4102 B2  
Önorm B1/Q1 | NF D 60 013 | UNI 9175 11M  
US Cal. Bull. 117-2013 | NFPA 260 | IMO A.652 (16)

**Fastness to light** Note 5-7, ISO 105-B02

**Fastness to rubbing** (ISO) dry 3-5, wet 3-5

**Pilling** Note 3, EN ISO 12945



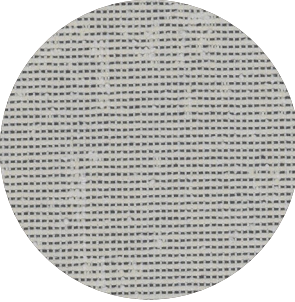

**Category** E

**Composition** 100% Trevira CS

**Weight** 700 g/lin.m

**Abrasion resistance**

35.000 rubs acc. to the Martindale method, EN ISO 12947

**Flammability** EN 1021-1/2 | DIN 4102 B1 | Önorm B1/Q1  
NF D 60 013 | NF P 92 507 M1 | UNI 9175 11M  
UNI 9177 classe 1 | US Cal. Tech. Bull. 117  
IMO A.652 (16)

**Fastness to light** Note 5-8, ISO 105-B02

**Fastness to rubbing** (ISO) dry 4-5, wet 4-5

**Pilling** Note 4, EN ISO 12945



# Dimensions

## BuzziTile Square L

Front

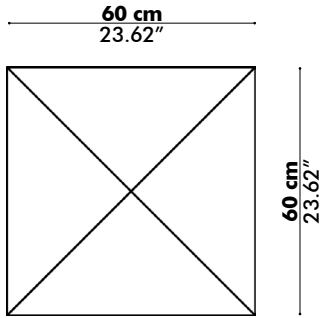

Thickness

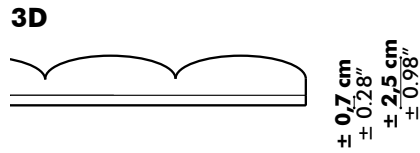

Flat

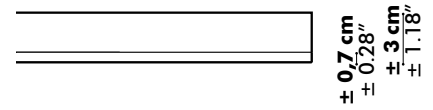

Back with powermagnets

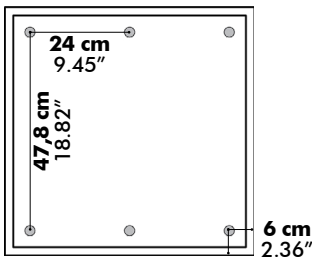

Positive | negative magnet location

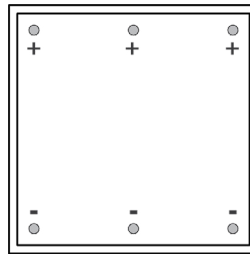

Back with self adhesive tape

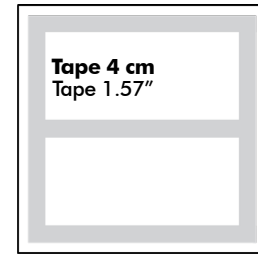

## BuzziTile Square XL

Front

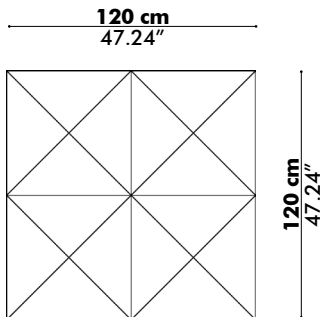

Thickness

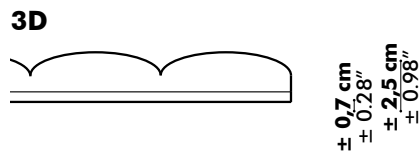

Flat

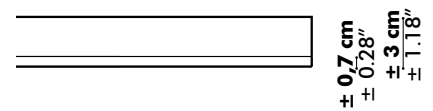

Back with powermagnets

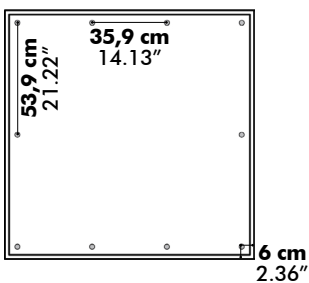

Positive | negative magnet location

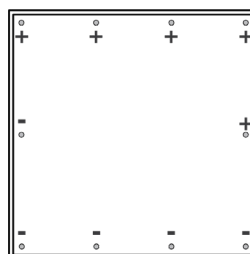

Back with self adhesive tape

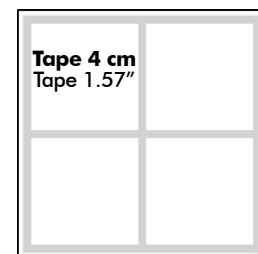

# BuzziTile Metro

## Front

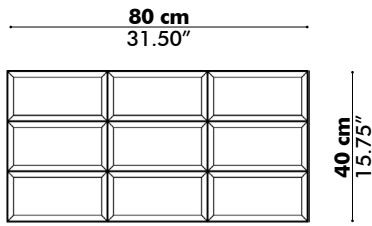

## Thickness

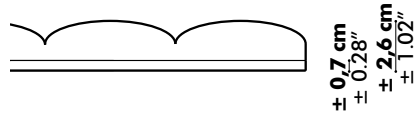

## Back with powermagnets

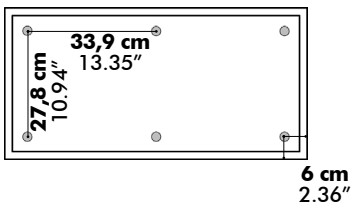

## Positive | negative magnet location

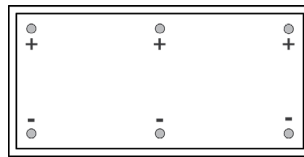

## Back with self adhesive tape



# BuzziTile Hexa

Front

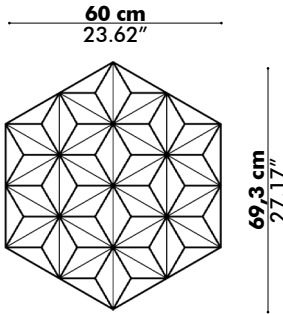

Thickness

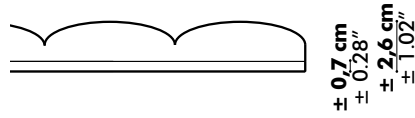

Back with powermagnets

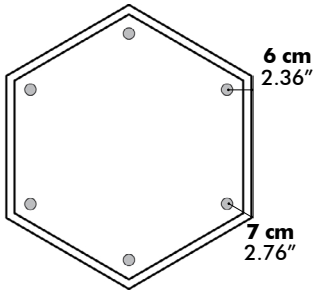

Positive negative magnet location

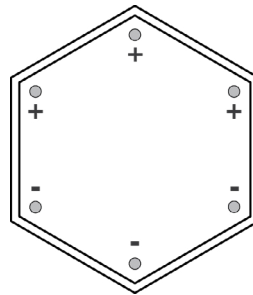

Back with self adhesive tape



# BuzziTile Penta

Front

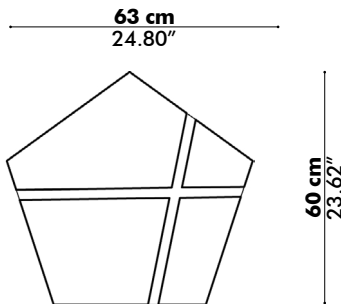

Thickness

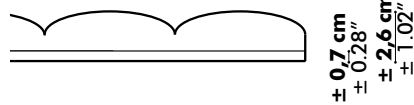

Back with powermagnets

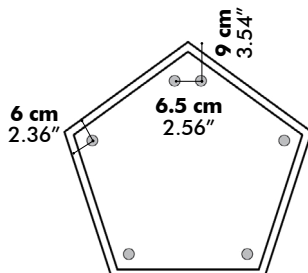

Positive negative magnet location

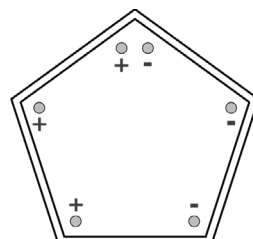

Back with self adhesive tape

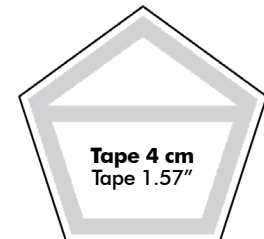

# BuzziTile Triangle L

Front

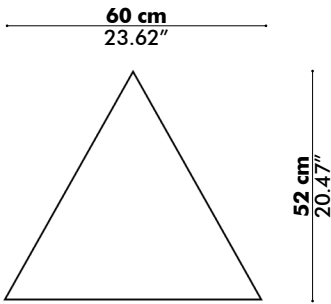

Thickness

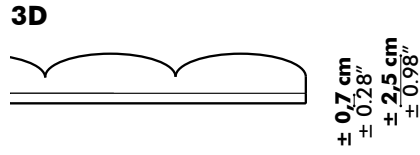

Flat

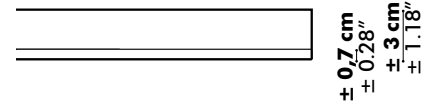

Back with powermagnets

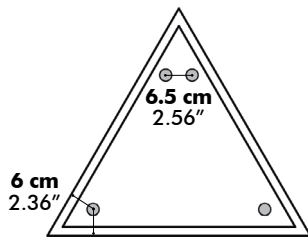

Positive negative magnet location

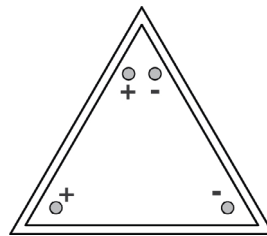

Back with self adhesive tape

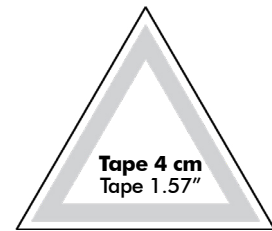

# BuzziTile Triangle XL

Front

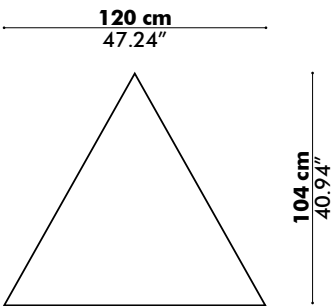

Thickness

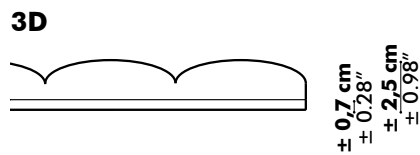

Flat

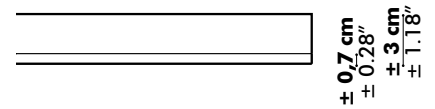

Back with powermagnets

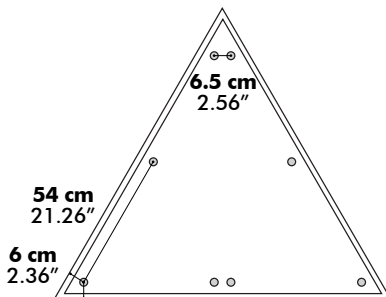

Positive negative magnet location

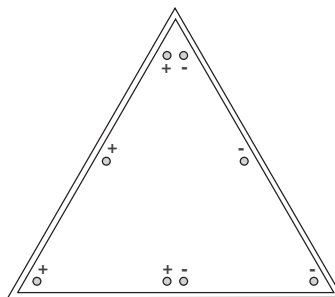

Back with self adhesive tape

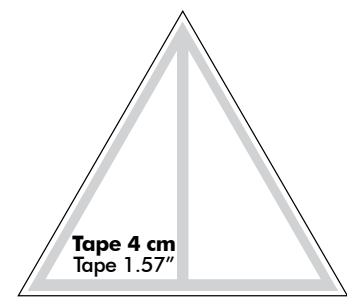



# Acoustics

## BuzziTile

### Absorption coefficient

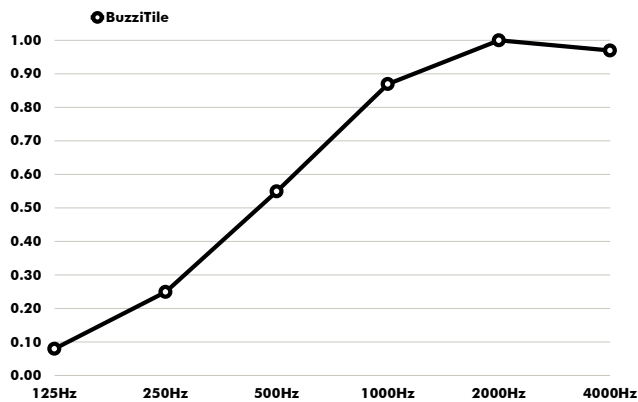

Hz	$\alpha^s$
125	0.08
250	0.25
500	0.55
1000	0.87
2000	1.04
4000	0.97

### Absorption values

$\alpha_w$  (ISO 11654) **0.55**

NRC (ASTM - C423) **0.70**

SAA (ASTM-C423) **0.68**

Class (ISO 11654) **D**

## Glossary

All calculations are based on accredited lab measurements, official document available on [www.Buzzi.Space](http://www.Buzzi.Space)

### Definitions

<b><math>\alpha</math></b>	Weighted absorption coefficient	(ISO 11654)
<b>NRC</b>	Noise reduction coefficient	(ASTM - C423)
<b>SAA</b>	Sound absorption average	(ASTM - C423)

### Classification of sound absorbers NEN-EN-ISO 11654

<b>A</b>	0.90   0.95   1.0
<b>B</b>	0.80   0.85
<b>C</b>	0.60   0.65   0.70   0.75
<b>D</b>	0.03   0.55
<b>E</b>	0.15   0.25

